

DOOR HARDWARE

13TH EDITION



TURNSTYLE
DESIGNS

MADE IN ENGLAND

*'Form follows function - that has been misunderstood.
Form and function should be as one, joined in a spiritual union.'*

Frank Lloyd Wright



Shown here – Solid Bridge S5004 door lever in Polished Nickel

About us

Turnstyle Designs was founded in 1992 by Steve Roberts. The company, family owned and run, is now one of the regions largest employers and operates out of its own purpose-built factory in Barnstaple. Employing a wealth of talent from craftsmen, engineers and an excellent sales team, who all take great pride in producing and delivering some of the worlds finest door and cabinet hardware.

Turnstyle produce a broad palette of products, using a wide choice of materials including hand stitched leather, machined and hammered brassware, as well as its own composite called Amalfine™. Turnstyle also use a range of custom materials including glass, shell and timber.

Turnstyle is proud to have supplied luxury hardware to many prestigious projects over the years, including luxury yachts, private residences, hotels and private clubs. From the eight stitches per inch to the cotton sleeve every handle is delivered in, attention to detail runs through the veins of the company in every aspect of business. The pride in producing each product is evident in its quality of design and service.

As proud winners of The Queens Award for Export, Turnstyle export over 75% of it business to dealer partners in over 30 countries around the world.





Environmental Ethos

Sustainability is a part of the Turnstyle DNA and we strive to be continually responsible with the materials we use, how we deal with waste and reducing our carbon footprint.

We have removed 99% of single use plastics from our packaging and replaced them with fast and completely biodegradable alternatives. We operate from a highly insulated factory and offices, using our own solar energy source. We recycle everything where possible, including canteen waste.

Even our materials are environmentally conscious, such as our leather which is tanned with natural vegetable dyes sourced from Italy. Our trademark Amalfine™ material is also made up of a composite blend, which includes by-products such as marble dust. Best of all we make our handles to last, strongly believing that if you buy well there is only a need to buy once.

We are working hard with all our staff to cut down air-travel, and endeavour to replace as many face to face meetings as we can with online sales and training sessions. Our 'Bike to Work' incentive scheme offers team members the opportunity to reduce their carbon emissions, while keeping fit and all our in-house food ordering is organic and locally produced.

With donations for tree preservation and planting, we have offset our carbon footprint three-fold, making us carbon negative. As proud members of '1% for the planet', we donate 1% or more of our annual turnover to environmental causes and organisations.



Living finishes

Living finishes are designed to change with time and use. Our brass components are polished and then treated using a number of different processes to change the surface, either by accelerated aging as with the Vintage and Burnished finishes or brushing as with our Satin Brass.

All living finishes are finished with a highly durable wax, which will wear according to use, we do not use Lacquer, so as to avoid uneven blotchy wear.

Brass living finishes can be used outdoors, but will be subject to the specific atmosphere of the location and change accordingly.

Brass Living



Polished Brass (PU)

Solid brass, expertly polished to a high sheen, pure and simple with nothing added to allow the natural aging process or keep it polished with any good brass cleaning products. **LV-EXT**



Vintage Patina (VP)

Hand polished brass base, matt treatment before patinated to a rich dark brown, lightly distressed for highlights. Finished with a durable wax coating. **LV-EXT**

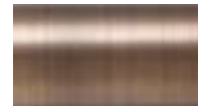

Fine Antique Brass (FA)

Hand polished brass, lightly patinated and brushed to highlight and contrast. Finished with a durable wax coating. **LV-EXT**



Satin Brass (TW)

Hand polished, then wire brushed for a golden finish. Wax coated. This finish will darken with age unless kept polished. **LV-INT**



Vintage Nickel (VN)

Nickel plated brass, skilfully patinated by our team of craftsmen, followed by hand distressing and wax polishing. **LV-INT**

Hammered Living



Polished Brass (PU)

Solid brass, expertly polished, then hammered and polished a second time to a high sheen, with subtle light refraction. Either allow the natural aging process or keep it polished with any good brass cleaning products. **LV-EXT**



Burnished Brass (BH)

For our hammered finishes we use a more gentle technique to patinate, each piece is hand burnished to break the surface before being patinated, then subtly distressed, hand polished and waxed to give a luxurious antique finish, highlighting every hammer blow perfectly. **LV-EXT**



Burnished Nickel (NH)

Polished solid brass, individually hammered, then nickel plated before being hand burnished, patinated and distressed to be finished with a wax finish. Eight pairs of hands before assembly, QA and packing. **LV-INT**

Brass Plated



Bright Chrome (BC)

Sometimes referred to as Polished Chrome, solid brass base, highly polished, nickel base coat with a durable chrome top coat. Easy to maintain and our most durable finish. **PL-EXT**



Polished Nickel (PN)

Solid brass base, finished with our beautifully subtle nickel plating, silver with hints of yellow. Superb in contemporary or traditional interiors. Clean with any quality nickel polish. **PL-INT**



Satin Nickel (SN)

Still our most popular plated finish, solid brass with a fantastic, flat satin nickel plating, no brushwork. A superbly versatile finish that will stand the test of time. **PL-INT**



Matt Black Chrome (CB)

Our latest addition to our plated finishes, a four step process developed by our highly skilled team of finishers, this is a completely matt black plated finish. Highly durable and practical for interior or exterior use. **PL-EXT**

Hammered Plated



Bright Chrome (BC)

Solid brass hand polished then individually hammered, before plated with a crisp and bright chrome plating. Highly reflective hammer blow texture that is easy to maintain and our most durable finish. **PL-EXT**



Polished Nickel (PN)

As with Chrome, solid brass, polished, hammered and re polished before being finished with our beautifully subtle nickel plating. Superb in contemporary or traditional interiors. Clean with any quality nickel polish. **PL-INT**



Satin Nickel (SN)

Solid brass, polished, individually hammered a thousand times, and finished with a fantastic, flat satin nickel plating, no brushwork. A superbly versatile finish that will stand the test of time. **PL-INT**

Code: LV - living finish. INT - interior use only. EXT - interior or exterior use. PL - plated finish

Amalfine™

Turnstyle Designs own proprietary composite blend of materials has been perfected over the past 28 years. Each finish is made up of its own unique blend of materials that run throughout the handle. Every piece is hand cast and hand machined before being finished in 2-3 separate processes that can take up to four hours to produce the perfect finish.

Warm to the touch, tactile and incredibly detailed our Amalfine™ finishes are also extremely durable and maintenance free. Each design and pattern translates differently according to the finish, see our website to view all designs in all finishes.

Please note Amalfine™ designs are recommended for interior use only.

Amalfine™

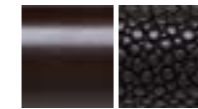

Cocoa (CO)

Dyed marble composite, plain designs reminiscent of mid century Bakelite.

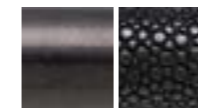

Black Bronze (BB)

Dyed marble mixed with real bronze, highly polished to bring out the bronze highlights, a rich black that will go well in any interior.

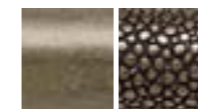

Silver Bronze (SB)

Heavily loaded cold cast bronze, highly polished and waxed to produce a rich dark golden finish.

Amalfine™

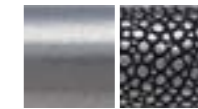

Alupewt (AP)

A secret blend of composite metals, polished and dyed to bring out the highlights in the more detailed designs such as Shagreen.



Sand (SA)

Only available with specific designs such as Shagreen, Labyrinth, Hickory and Bullet. Dyed marble, with a dark stain to produce a highly unique finish.



Bone (BN)

Made to order only, and only applicable to non textured designs.

Leather

Turnstyle Designs have been making leather door and cabinet hardware for more than 20 years, far longer than any of our imitators. Perfecting the process, all our handles are bonded and hand stitched using only the finest full grain, vegetable tanned bridal leather.

Woven Leather

Four classic finishes made from seamless cross weave leather, supplied by a small Italian specialist that has perfected the art of weaving flat strands of leather into seamless tubes. Bonded onto specially produced recessed brass work to retain and preserve the cut ends.



Chestnut (CN)

A glorious, reddish, nutty brown, full of life and finished with a natural, off white thread.



Chocolate (CT)

A rich dark brown, our most popular colour, finished with a dark brown thread.



Black (BL)

A beautiful, subtle sheen, classic leather, finished with a black thread.



Tan (TA)

Light, luxurious leather, edged with a soft, natural thread.



Slate (GC)

A mid tone grey, growing in popularity, great with our silver plated finishes and edged with a silver grey thread.



White (BW)

White leather, white thread, white edging for a clean and contemporary look.

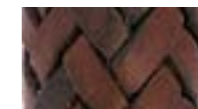

Tobacco (TC)

A reddish brown mix of woven strands to produce our best selling classic.



Flint Grey (FG)

A beautiful mid grey with a subtle dark smoked undertone.



Whisky (WK)

A light tan mix with dark edging.



Raven Black (RV)

Like the bird, a beautiful reflective black sheen, that comes alive as light catches it.

Leather like all natural materials will change with age, according to the situation, exposure to sunlight and usage (or lack of). The more you use it, the better it looks, the oils from your hands feed the leather and create a unique patina. Leather handles should only be used internally. Please see our leather care instructions for maintenance and cleaning.

Colour Variation

Vegetable tanning is an art rather than a science, please allow for slight variations in colour from batch to batch, this is all part of the charm of using such a beautiful and natural material.



Design Your Handle

Select and filter your design, finishes or sizes using our website tool.

We are proud to have one of the most progressive websites in our industry, with a simple to use configuration tool which allows you to view every one of our designs in every combination of grip and body, leather, Amalfine™ and brass.

Choose your design, finish and size, download the specification sheet and then request your pricing. Our sales team will then send you a quote and tell you how to buy.

You can also keep up to date on our latest news, developments, events and dealerships, as well as read our blog where you will find interesting posts about what we are up to as a business and team.



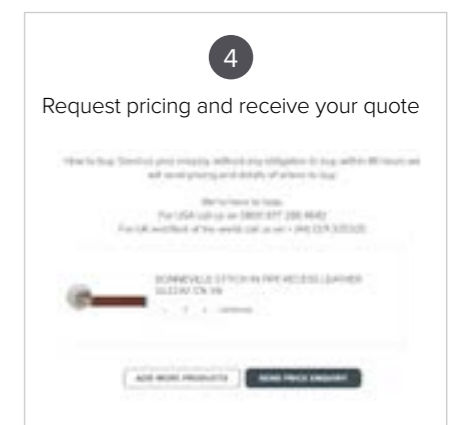
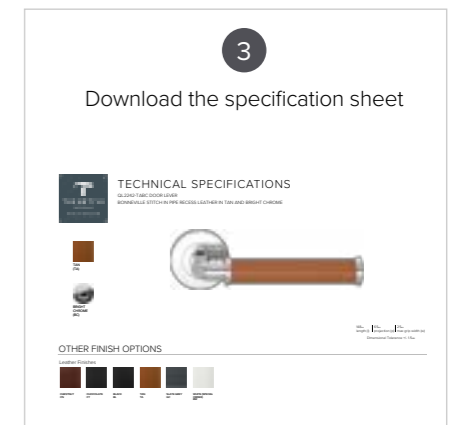
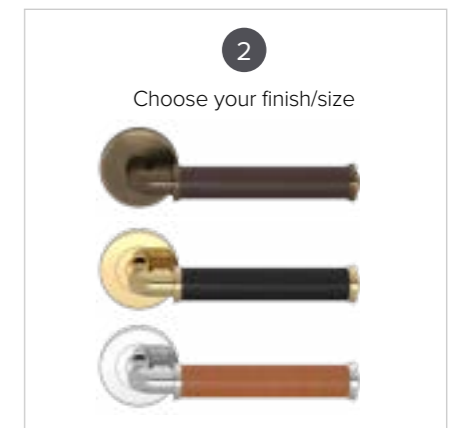
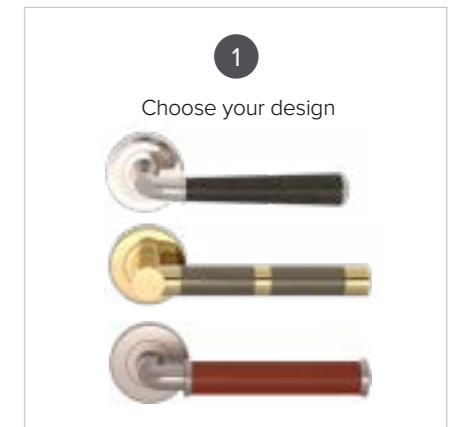







www.turnstyledesigns.com



contents

	back plate options	13
	door lever roses	15
	Amalfine™ manufacturing	17
	goose neck combination door levers on classic rose	19
	goose neck combination Amalfine™ door levers	20
	Bullet combination Amalfine™ door levers	22
	Bullet goose neck combination Amalfine™ door levers	23
	pipe recess Amalfine™ Norton door lever	25
	combination Amalfine™ door levers	26
	recess Amalfine™ door levers	30
	stepped recess Amalfine™ Labyrinth door lever	33
	balance Amalfine™ Hickory door lever	35

	solid brass hammered manufacturing	37
	solid hammered door levers	38
	solid door levers	41
	leather manufacturing	45
	recess leather door levers	46
	recess woven leather door levers	49
	pipe recess leather Bonneville door levers	51
	combination leather door levers	53
	recess Amalfine™ stacked door knobs	57
	recess Amalfine™ Layer door knobs	59
	solid, hammered, recess leather door knobs	61
	combination Amalfine™ and solid door knobs	63

	escutcheons and key hole covers	65
	thumb turn sets	66
	door stops and hardware	68
	locks and hinges	69
	solid pocket/sliding hardware	71
	recess leather pocket/ sliding door pulls	73
	recess leather, and solid lift and slide handles	76
	tilt and turn window handles	77
	solid and combination T bar handles	78
	solid and recess T bar handles	79

contents

	recess Amalfine™ pull handles	82-85
	stepped recess Amalfine™ Labyrinth pull handles	87
	goose neck combination Amalfine™ pull handles	88
	solid and hammered pull handles	91
	recess leather pull handles	95
	gooseneck combination leather pull handles	97
	push plates	98
	recess leather pull handles	99-101
	recess woven leather pull handles	103
	customisation	107
	dimensions	110
	index	114

back plate options

All door levers are available with a choice of three back plates, configured lever up or lever down (for the USA). Please specify keyhole profile and centre or thumb turn and centre size when ordering. All levers are available in mixed pairs (by finish and design) please specify handing when ordering. Back plates are cast from solid brass and available in all finishes.

Shown here in Alupewt with Satin Nickel.

Up to 9 finishes per design, visit turnstyledesigns.com

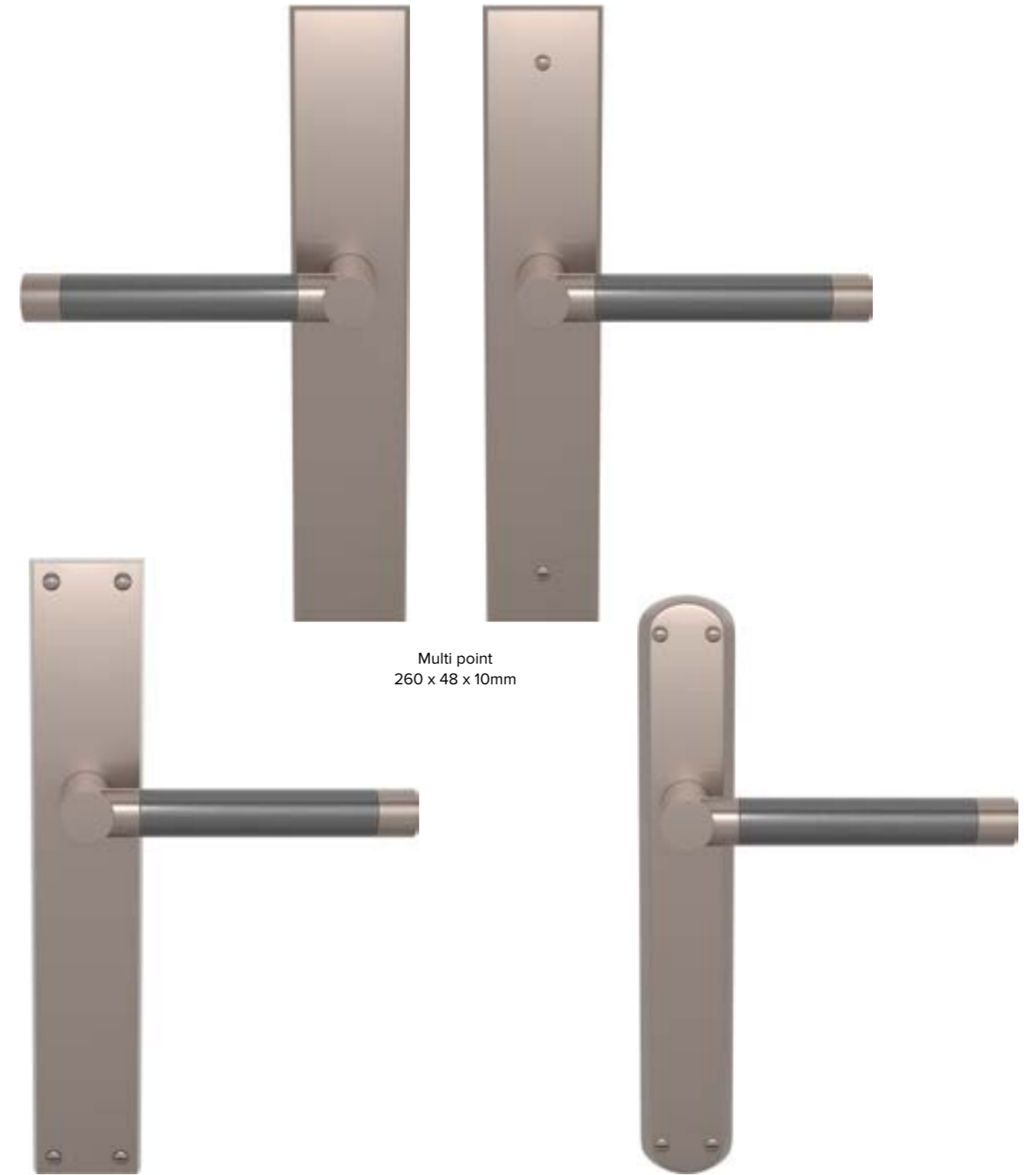

Multi point
260 x 48 x 10mm

Rectangle plate
260 x 47 x 10mm

Slimline plate
254 x 41 x 10mm

Shown here – Bonneville Solid door lever on a Multi point backplate in Satin Nickel

For full technical specifications contact our sales department or visit www.turnstyledesigns.com

rose options

All of our European roses (apart from the Flat and Classic Rose) are sprung loaded, through bolted, (horizontal or vertical) for extra security and fixing, levers are attached to roses and supplied with 8mm piercing spindles.

Up to 9 finishes per design, visit turnstyledesigns.com

Levers on roses are configured for use on a 45mm thick door. Please specify for thicker doors, kits available for doors up to 100mm door thickness.

Shown here in Alupewt with Satin Nickel.



52mm round rose



52mm Classic rose



52mm flat round rose



52mm scallop rose



52mm square rose



58mm round rose



52mm privacy rose



2 Part Pre Bore 62mm USA round rose. Comes complete with easy to fit sprung loaded pre bore kit and tubular latch. Also available with push button privacy option.



52mm square privacy rose



2 Part Pre Bore 62mm USA square rose. Comes complete with easy to fit, sprung loaded pre bore kit and tubular latch. Also available with push button privacy option.

*Privacy function also available on 52mm scalloped rose, 58mm round rose and US pre bore roses.

For full technical specifications contact our sales department or visit www.turnstyledesigns.com



Photo courtesy of Mangusta 165E - Armatore www.mangustayachts.com
Shown here - Shagreen Barrel Door Lever on square rose in Black Bronze with Satin Brass



Shown here – Banded Egg Door Knobs

Amalfine™ manufacturing

Amalfine™ is a composite blend which has become one of our trademarks and is entirely unique to Turnstyle.

Incredibly versatile and durable, each piece is hand cast, finished and will pass through at least eight pairs of hands before finally being packed for dispatch. Every piece is unique with its own individually crafted character and charm.

The finishes in the Amalfine™ range are more like materials than finishes, the colour runs throughout the design so unlike a surface finish it cannot wear off.

Using highly flexible silicone rubber moulds we are able to reproduce finger print detail from the masters we cast from and de-mould the parts without a seam.

After de-moulding, each design is carefully machined down to remove excess material and where applicable to accurately fit its brass partner.

After around six to eight hours of various polishing stages the beautiful lustre will remain for many years to come.

Every piece is unique with its own individually crafted character and charm.

Turnstyle also offer a Custom Casting and finishing service. For better understanding of the process visit our website and view the production movies www.turnstyledesigns.com



goose neck combination door levers on classic rose

A selection of our more classically styled Goose Neck door levers now available on our smaller, more refined and traditional Classic rose.

Unsprung and face fixed for a more classic look.

Shown here in Cocoa and Chocolate Leather with Fine Antique and Burnished brass.

Up to 54 finish combinations per design, visit turnstyledesigns.com



Tube (stitch in) CF4090



Faceted Tube DF3556



Tube (stitch out) CF5050



Shagreen Tube DF4123



Tube SF6060



Tube DF6060



Tube hammered HF6060



Flute DF4455



Flute SF4455

goose neck combination Amalfine™ door levers

The soft angular goose neck shaft complimented with its scalloped rose produces more elegant door lever options with nine distinct lever grips. As with all Turnstyle products, each design is available in multiple combinations of grip and metal finishes, all configurable on our website. Shown here in Silver Bronze with Vintage Nickel.

 Up to 45 finish combinations per design, visit turnstyledesigns.com



Flute DF3260



Plain DF3025



Shagreen Tube DF2988



Faceted Tube DF3270



Tube DF3015



Woven Tube DF1175



Bamboo DF3009



goose neck combination Amalfine™ door levers

 Up to 45 finish combinations per design, visit turnstyledesigns.com

combination Amalfine™ Bullet door levers

Fast moving, long and slender, this ergonomic lever shows off our Amalfine™ finishes perfectly. A great transitional design, suitable for both contemporary or more traditional interiors.

Shown here in our five Amalfine™ finishes with Satin Nickel.

Up to 45 finish combinations per design, visit turnstyledesigns.com to view



Bullet D3200
Alupewt



Silver Bronze



Cocoa



Black Bronze



Sand

goose neck combination Amalfine™ Bullet door levers

Up to 45 finish combinations per design, visit turnstyledesigns.com to view



Bullet DF3290
Alupewt



Silver Bronze



Cocoa



Black Bronze



Sand

Above images are computer generated renders, please allow for some variation from actual product.

Dimensions index p108. For full technical specifications contact our sales department or visit www.turnstyledesigns.com

Above images are computer generated renders, please allow for some variation from actual product.

Dimensions index p108. For full technical specifications contact our sales department or visit www.turnstyledesigns.com



pipe recess Amalfine™ Norton door lever

A large, bold design with a heavily grooved grip, creating a tactile feel, much like grabbing the handle of a motor bike. The Norton grip is set on our new Pipe lever shaft and comes in four different Amalfine™ finishes, as well as Solid Brass. Detailed with complimentary classically lined caps and collars, this strong design makes the perfect statement piece.

Shown here in four of our Amalfine™ finishes with Vintage Patina.



Up to 36 finish combinations per design, visit turnstyledesigns.com



Norton QA2020
Silver Bronze



Black Bronze



Cocoa



Alupewt

Above images are computer generated renders, please allow for some variation from actual product.

Dimensions index p108. For full technical specifications contact our sales department or visit www.turnstyledesigns.com

combination Amalfine™ door levers

Eight distinctly different door lever grips, hand cast in our trademark Amalfine™ composites. Tactile as well as durable, our Amalfine™ materials are not finishes but solid blends of metals and marbles, each polished for hours to produce a beautifully subtle sheen.

Shown here in Alupewt with Bright Chrome.



Plain D1002



Flute D3240



Tube D1332



Faceted Tube D3280



Bamboo D1001



Shagreen Tube D2005



Woven Tube D1182

combination Amalfine™ door levers

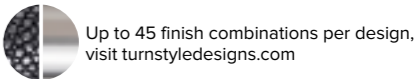



Shown here – Flute Door Lever in our five Amalfine™ finishes with Polished Nickel

recess Amalfine™ door levers

A more contemporary profile handle combined with a varied choice of Amalfine™ grips from our very popular Shagreen to the luxurious Chesterfield. Transitional designs for every interior. Shown here in Black Bronze with Polished Nickel.

Up to 45 finish combinations per design, visit turnstyledesigns.com



Bamboo Barrel P2856



Faceted Barrel P1440



Wire P2702



Barrel P1333



Banded Barrel P2771

recess Amalfine™ door levers

Up to 45 finish combinations per design, visit turnstyledesigns.com



Chesterfield P2670



Woven P2765



Shagreen P1019



Rough Cut P1015

stepped recess Amalfine™ Labyrinth door lever

The Labyrinth was designed in collaboration with Winch Design. It is a bold, striking design, inspired by a mixture of complex geometric and organic tones. The Step framework comes with a large 25mm diameter grip, over hung and set on a 58mm rose. The grips are hand cast and finished in Turnstyle Designs Amalfine™ composites and are available in five beautiful finishes. Shown here in our full Amalfine™ options with Vintage Patina.

 Up to 45 finish combinations per design, visit turnstyledesigns.com



Shown here – In Black Bronze with Vintage Patina and Silver Bronze with Fine Antique Brass



Labyrinth **B7005**
Black Bronze



Alupewt



Cocoa



Silver Bronze



Sand

Above images are computer generated renders, please allow for some variation from actual product.

Dimensions index p108. For full technical specifications contact our sales department or visit www.turnstyledesigns.com



balance Amalfine™ Hickory door lever

The Hickory lever was inspired by the North American hunting knives, often referred to as "Old Hickory". A simple Amalfine™ flat moulded grip finished with a stud fixing and set on a clean, unsprung, flat rose. A new twist on a door lever and a great choice for anyone looking for something original to add that finishing touch. Shown here in our five Amalfine™ finishes with polished brass.

Up to 45 finish combinations per design, visit turnstyledesigns.com



Hickory E3500
Cocoa



Black Bronze



Alupewt



Silver Bronze



Sand

Shown here – on Rectangle Backplate with Alupewt with Satin Nickel

Above images are computer generated renders, please allow for some variation from actual product.



Shown here – Hammered Bridge Door Lever

Solid Brass

Turnstyle uses a host of manufacturing processes to produce the very best result for each design and product. These include CNC machining, turning, milling, forging, investment casting and extrusion. All carried out by highly skilled precision engineers.

A selection of our Solid designs are available with our hammered texture applied. Every design is individually hammered with up to a thousand hammer blows per grip, each handle is made to order and completely unique. Whatever finish you wish to apply, our Hammered range is a luxurious option and versatile enough to work in any interior.



solid hammered door levers

It takes a lot of skill and many hours of hard work to produce our hammered door handles. Hand polished, then individually hammered before being hand burnished, patinated and waxed for a more vintage finish with a contemporary look. Functional artwork engineered to last.

Shown here in Burnished Nickel.



Up to 6 finishes per design, visit turnstyledesigns.com



Square **HS1526**



Ski **HS1022**



Bridge **HS5004**



Three Part Barrel **HS2037**



Barrel **HS1333**



Tube **HS1332**



Goose Neck Tube **HF3015**

solid hammered door levers



Up to 6 finishes per design, visit turnstyledesigns.com



Tube **HS1332**



Barrel **HS1333**



Goose Neck Tube **HF3015**



Pipe Bonneville **QH2700**



Three Part Barrel **HS2037**

Twelve beautiful and diverse designs made in solid brass, hand polished. Plated or patinated. Shown here in Polished Nickel.

Up to 11 finishes per design, visit turnstyledesigns.com



Shown here – in Matt Black Chrome



Oval Angle S1429



Ski S1022



Square S1526



Three Part Barrel S2037



Barrel S1333



Bridge S5004



Above images are computer generated renders, please allow for some variation from actual product.

Dimensions index p108. For full technical specifications contact our sales department or visit www.turnstyledesigns.com

Two new additions to our Solid door levers, The Norton and Bonneville, both inspired by British biking classics, reassuringly robust. Shown here in our ever popular Satin Nickel.

Up to 9 finishes per design, visit turnstyledesigns.com



Shown here – Bonneville Solid Door Lever in a selection of finishes



Pipe Bonneville QS2700



Goose Neck Flute SF3260



Pipe Norton QS2020



Goose Neck Tube SF3015



Tube S1332



Flute S3240

Above images are computer generated renders, please allow for some variation from actual product.

Dimensions index p109. For full technical specifications contact our sales department or visit www.turnstyledesigns.com



Shown here – Recess Leather Barrel T bar handles

Leather manufacturing

Our leather is sourced from some of the finest tanneries in the world in Tuscany, Italy. We use only the very best full grained (top and strongest section), vegetable tanned (all natural), drum dyed, bridle or saddle leather.

Leather like all natural materials will change with age, according to the situation, exposure to sunlight and usage or lack of. The more you use it, the better it looks, the oils from your hands feed the leather and create a unique patina. Like an old handbag or briefcase the character of the leather gets richer with age.

Colour Variation

Vegetable tanning is an art rather than a science, please allow for some variations in colour from batch to batch and even from hide to hide in some cases. This is all part of the charm of using such a beautiful and natural material.

Wear and Care

As with a good handbag or pair of shoes the leather will appreciate being fed from time to time, we recommend twice a year with a good quality leather cream, or we can supply a recommended cream if you wish.

Do not clean with solvents or chemicals, as this will not only affect the leather but also soak through and destroy the glue. Scratches and dents can be removed by a simple “boning” process that brings the oils back to the surface and repairs by simply working the leather area in circular motions with a boning tool (or the back of a spoon).

If the leather gets dirty use a small amount of soapy water, let it dry and finish with a natural wax. Try and remove dust if the handles are not being used, as dust dries out the leather.

With a small amount of care your handles will last for years and years to come.

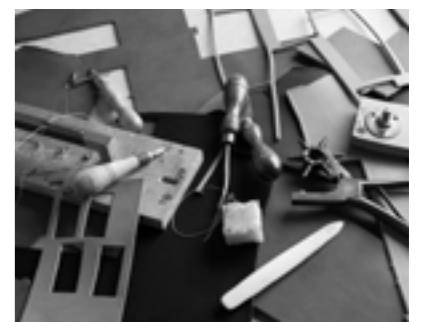
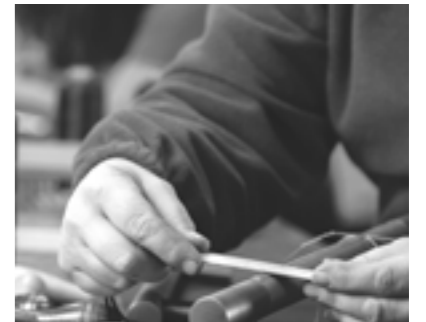

recess leather door levers

Contemporary square profile with edges hand polished for a softer grip. Solid brass with hand stitched and bonded Italian leather grips, stitch in or out – you choose.

Shown here in Black Leather with Polished Brass.

Up to 54 finish combinations per design, visit turnstyledesigns.com

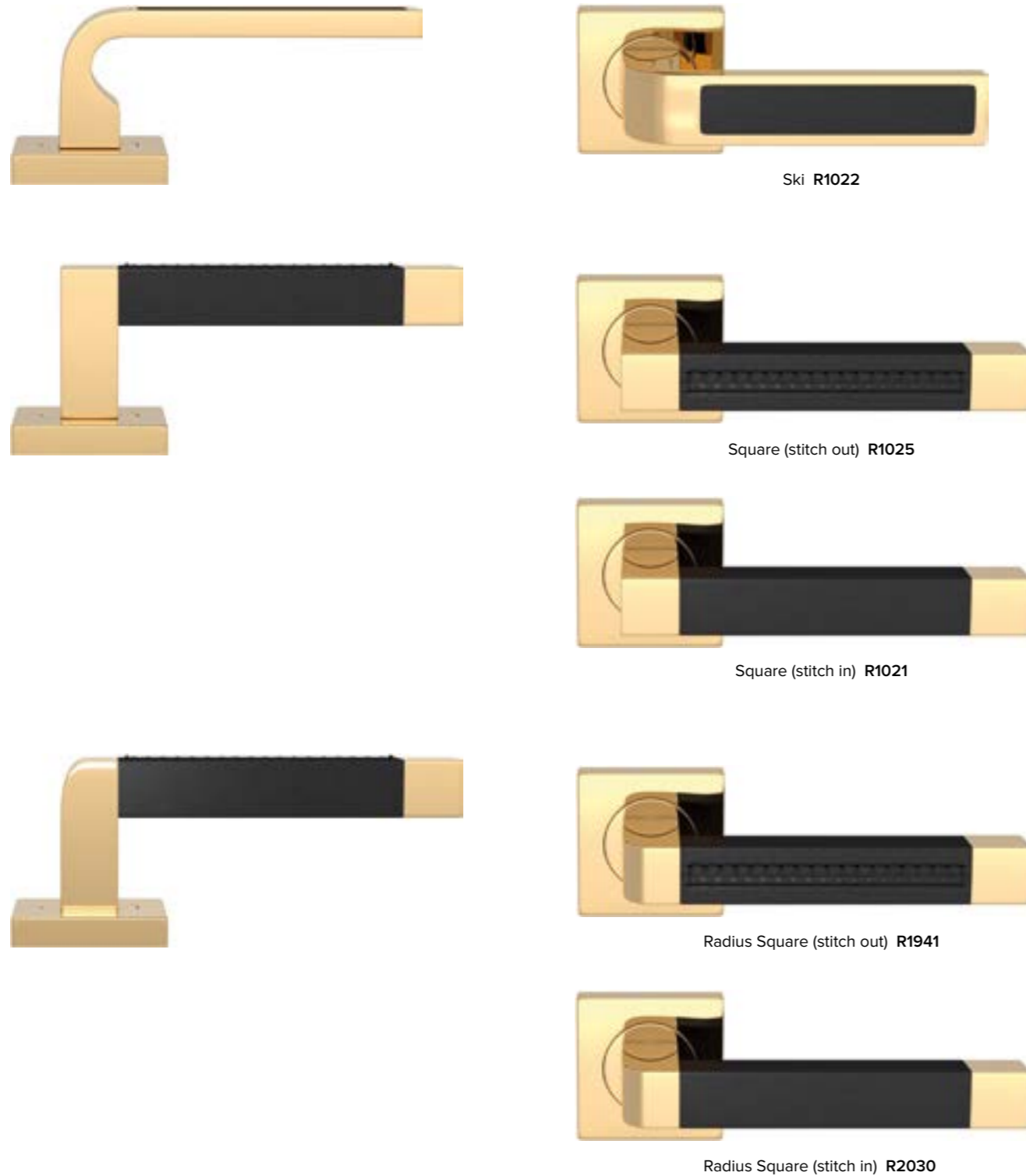

recess leather door levers

Machined brassware with standard 19mm grips or 22mm Large Barrel for larger doors or hands. Available in all our beautiful leather finishes combined with our diverse choice of metal finishes.

Shown here in Black Leather with Polished Brass.

Up to 54 finish combinations per design, visit turnstyledesigns.com





Shown here – In Tobacco Leather with Polished Nickel

recess woven leather door levers

Seamless, woven leather tubes, bonded and capped, available with matching pull handles – see page 103.

Shown here in our four luxurious woven leather finishes with Fine Antique Brass.

Up to 36 finish combinations per design, visit turnstyledesigns.com



Woven barrel R2076

Tobacco



Flint Grey



Whisky



Raven Black

Above images are computer generated renders, please allow for some variation from actual product.

Dimensions index p109. For full technical specifications contact our sales department or visit www.turnstyledesigns.com



Shown here – Bonneville Recess Leather in five of our leather finishes with Fine Antique Brass

pipe recess leather Bonneville door levers

The Bonneville lever is inspired by the throttle of the classic British Triumph motorbike from the 1960s. A bold, adventurous design made for the hand and designed to ride the test of time.

Shown here in Chocolate leather with a selection of our metal finishes.

Up to 54 finish combinations per design, visit turnstyledesigns.com



Bonneville QL2242



stitch in QL2242
Bright Chrome



stitch out QL2004
Bright Chrome



stitch in | Satin Nickel



stitch out | Satin Nickel



stitch in | Polished Nickel



stitch out | Polished Nickel



stitch in | Polished Brass



stitch out | Polished Brass

Above images are computer generated renders, please allow for some variation from actual product.

Dimensions index p109. For full technical specifications contact our sales department or visit www.turnstyledesigns.com

combination leather door levers

Slimmer Tubes or ergonomic oval grips. Goose neck levers come with profiled Scalloped roses to match. Solid cast brass, with hand stitched, vegetable tanned, hardy leather grips. Shown here in Chestnut Leather with Satin Nickel.

Up to 54 finish combinations per design, visit turnstyledesigns.com



Tube (stitch out) **C1012**



Goose Neck Tube (stitch out) **CF2992**



Tube (stitch in) **C1000**



Goose Neck Tube (stitch in) **CF2987**



Oval Angle (stitch out) **C1414**



Oval Angle (stitch in) **C1013**





recess Amalfine™ stacked door knobs

A future Turnstyle classic, designed to co-ordinate with all of our other recess Amalfine™ products. Six of our best Amalfine™ designs seated and capped with finely machined brassware.

Shown here in Silver Bronze Amalfine™ and Polished Nickel



Up to 45 finish combinations per design, visit turnstyledesigns.com



Woven P6711



Barrel P4224

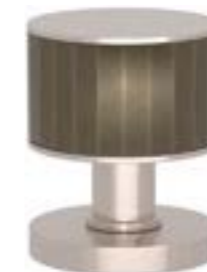

Faceted P6200



Wire P6587



Labyrinth B9303



Shagreen P6702

Shown here – Wire Door Knobs in Alupewt with Satin Nickel

Above images are computer generated renders, please allow for some variation from actual product.



recess Amalfine™ Layer door knobs

A bold 57mm diameter door knob, made with Amalfine™ layers, sandwiched between solid brass and set on a simple flat rose. Check out our website to view all the 45 combinations of finish options available along with the Bite thumb turn, designed to complement the Layer perfectly.

Shown here in Silver Bronze Amalfine™, with a selection of our brass finishes.



Up to 45 finish combinations per design, visit turnstyledesigns.com



Layer | P2244



Polished Brass



Polished Nickel



Fine Antique Brass



Bright Chrome



Vintage Nickel



Satin Nickel



Vintage Patina

Shown here – Layer Door Knob in Silver Bronze with four of our Brass finishes

Above images are computer generated renders, please allow for some variation from actual product.



solid, hammered and recess leather stacked door knobs

Three simple variations of our Stacked door knob, Solid Brass, Hammered Brass and Leather. Simple barrel designs, surprisingly comfortable to use, and a great option for a contemporary door knob which can be used fixed dead for cupboards or turning for latched doors.

Shown here in Polished Brass and Tan Leather with Polished Brass.

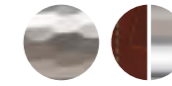

Up to 54 finish combinations per design, visit turnstyledesigns.com



Barrel Solid **S9200**



Barrel Hammered Solid **HS9200**



Barrel Leather **R4224**

Shown here – Stacked Barrel Door Knob In Matt Black Chrome with matching Bite Thumb Turn on Flat rose

Above images are computer generated renders, please allow for some variation from actual product.

Dimensions index **p109**. For full technical specifications contact our sales department or visit www.turnstyledesigns.com

combination Amalfine™ and solid door knobs

A contemporary twist on two classic door knob shapes, available with our new, matching Egg turn and release set. Shown here in Black Bronze and Polished Nickel.

Up to 45 finish combinations per design, visit turnstyledesigns.com



Shown here - Banded Egg and Saturn Door Knobs in Cocoa with Vintage Nickel



Banded Egg Amalfine™ D7568



Banded Egg Solid S7568



Saturn Amalfine™ D6633

Above images are computer generated renders, please allow for some variation from actual product.

Dimensions index p109. For full technical specifications contact our sales department or visit www.turnstyledesigns.com



escutcheons – key hole covers

Solid brass to match all our rose profiles and sizes.
Shown here in Satin Nickel.

Up to 11 finishes per design, visit
turnstyledesigns.com



Blank **S1423** Ø52mm



Euro **S1421** Ø52mm



Slotted **S1422** Ø52mm



Euro Scalloped **S1426** Ø52mm



Slotted Scalloped **S1428** Ø52mm



Slotted **S1478** Ø58mm



Slotted Flat **S7907** Ø52mm



Euro Flat **S7769** Ø52mm



Euro **S1450** Ø58mm



Slotted Classic **S5277** Ø52mm



Euro Classic **S5200** Ø52mm



Euro Square **S1424** □52mm



US Mortice cylinder collar and turn **S1630** Ø52mm



US Mortice cylinder collar and turn **S2764** □52mm



US Mortice cylinder collar and bite **S1725** Ø52mm



US Mortice cylinder collar and bite **S2802** □52mm



Above images are computer generated renders, please allow for some variation from actual product.

Dimensions index p109. For full technical specifications contact our sales department or visit www.turnstyledesigns.com

thumb turn sets

Turn and release sets for tubular or mortice bolts. Half Moon, Snib, Bite or Eggs, choose the design and rose to match your knobs and levers. All sets are sold with turn and release and to suit 8mm or 5mm followers. Shown here in Satin Nickel.

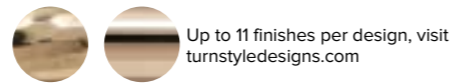

Half moon turn and release set **S1042** Ø52mm



Hammered Half moon turn and release set **HS1042** Ø52mm



Scalloped Half moon turn and release set **S3010** Ø52mm



Hammered Scalloped Half moon turn and release set **HS3010** Ø52mm



Half moon turn and release set **S1071** Ø58mm



Hammered Half moon turn and release set **HS1071** Ø58mm



Classic Half moon turn and release set **S5122** Ø52mm



Hammered Classic Half moon turn and release set **HS5122** Ø52mm



Half moon turn and release set **S1420** □52mm



Hammered Half moon turn and release set **HS1420** □52mm



Flat Half moon turn and release set **S2020** Ø52mm



Hammered Flat Half moon turn and release set **HS2020** Ø52mm



Snib turn and release set **S1041** Ø52mm



Bite turn and release set **S8234** Ø52mm



Scalloped Snib turn and release set **S3043** Ø52mm



Scalloped Bite turn and release set **S8536** Ø52mm



Snib turn and release set **S1076** Ø58mm



Bite turn and release set **S8400** Ø58mm



Flat Snib turn and release set **S3857** Ø52mm



Flat Bite turn and release set **S8007** Ø52mm



Snib turn and release set **S1046** □52mm



Bite turn and release set **S8425** □52mm



Egg turn and release set **S9559** Ø52mm *Available on this rose only

thumb turn sets

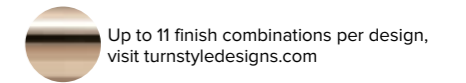

Solid brass door accessories to match your handles. Full range of accessories available, finished to match.
Shown here in Satin Nickel.

Up to 11 finishes per design, visit turnstyledesigns.com



Hooded door stop X1123



Round (wall/floor mounted) magnetic door stop X2046
*Available in Bright Chrome only



Pedestal door stop X1125



Square (wall mounted) magnetic door stop X2596



Wall or floor mounted door stop X1124



Lever action flush bolt X1121



Silent cabin hook X1126

In order to complete your collections, we offer complimentary hardware in all of our metal finishes.
Shown here in Vintage Patina, Polished Nickel and Fine Antique Brass.

Up to 9 finishes per design, visit turnstyledesigns.com



Hinges



USA 4"x4"



USA 4.5" x 4.5"
*Also available 4.5 x 4



UK 100mm x 75mm

Locks we supply UK, EU and USA locks.

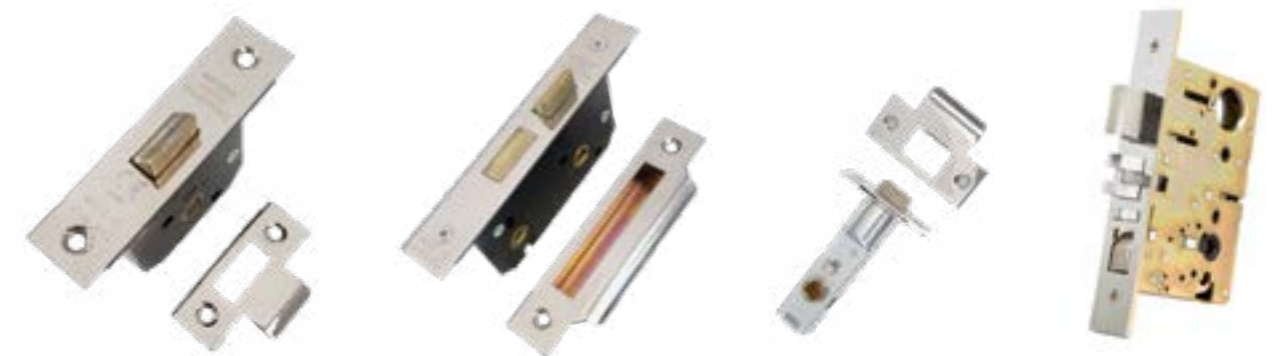

Full selection of Mortice locks and cylinders available



US Cylinder



Half Moon Euro Cylinder



Bite Thumb Turn

*Refer to pages 66 and 67 for turn piece options

solid pocket/sliding door pulls

A choice of fixed or turning flush fitted hardware, precision engineered to compliment your sliding or folding doors. Locks and latches also available. Shown here in Polished Brass.

Up to 9 finishes per design, visit turnstyledesigns.com



Round revolving flush pull **S1954**



Round fixed flush pull **S2829**



Pocket edge door pull **S1407**



Rectangle flush pull **S1955** turn



Rectangle flush pull **S1955** coin release



Rectangle flush pull **S1955** blank



Slimline flush pull **S1920**



Push button sliding door lock and pull **K2692**



Push button sliding door pull **K2693**

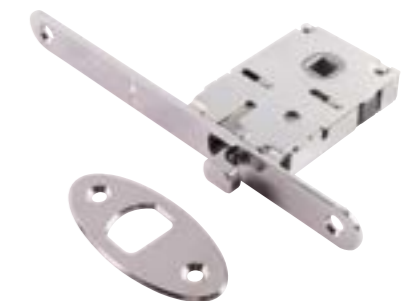

Sliding door privacy lock **K1500**

Shown here – Solid Slimline Flush Pull in Fine Antique Brass

Above images are computer generated renders, please allow for some variation from actual product.

Dimensions index p110. For full technical specifications contact our sales department or visit www.turnstyledesigns.com

recess leather pocket/sliding door pulls

Precision engineered brassware combined with flush fitted Italian bridle leather on the R3123 and R3150. The other designs are inlaid with faux leather, which gives the look and feel of leather inlay but prevents marking from fingernails... beautiful and practical... we think about what we make.

Shown in Black Tea Faux and Black Leather with Vintage Nickel.

Up to 54 finish combinations per design, visit turnstyledesigns.com

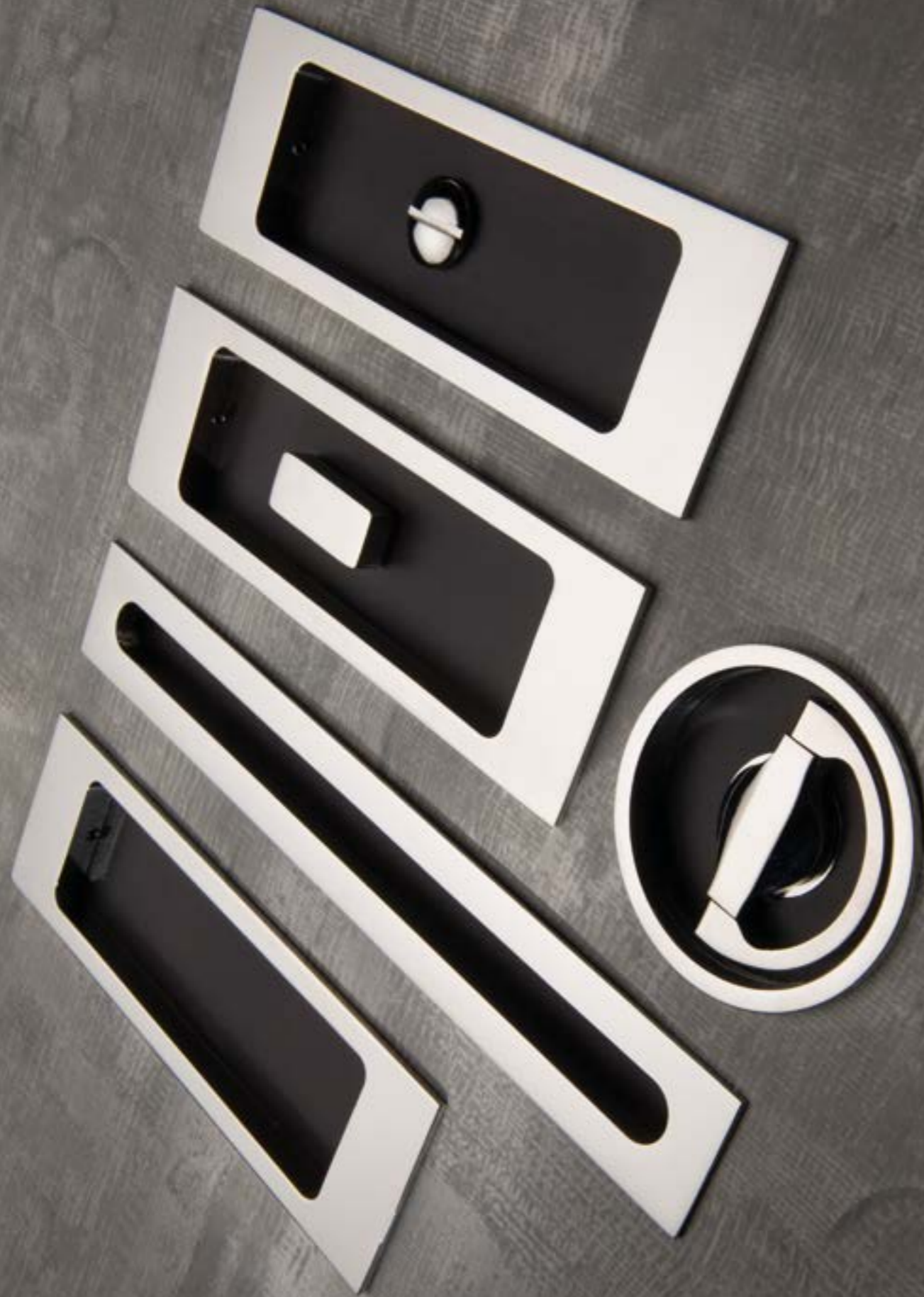

Shown here – in Black Tea Faux Leather with Satin Nickel



Round revolving flush pull **C1954**



Rectangle flush pull **R1955** turn



Rectangle flush pull **R1955** coin release



Rectangle flush pull **R1955** blank



Bordered recess leather flush pull **R3123**



Recess leather flush pull **R3150**



Slimline flush pull **C1959**

Above images are computer generated renders, please allow for some variation from actual product.

Dimensions index p110. For full technical specifications contact our sales department or visit www.turnstyledesigns.com



Shown here – Faceted collection in Black Bronze with Satin Brass

solid and recess leather lift and slide handles

Rectangle or oval profile through bolt rose options, these large 25mm diameter pulls are designed for lift and slide patio type doors or windows. Check with your manufacturer for suitability, also available with Euro profile lock rose options.

Shown here in Slate Grey Leather with Bright Chrome.

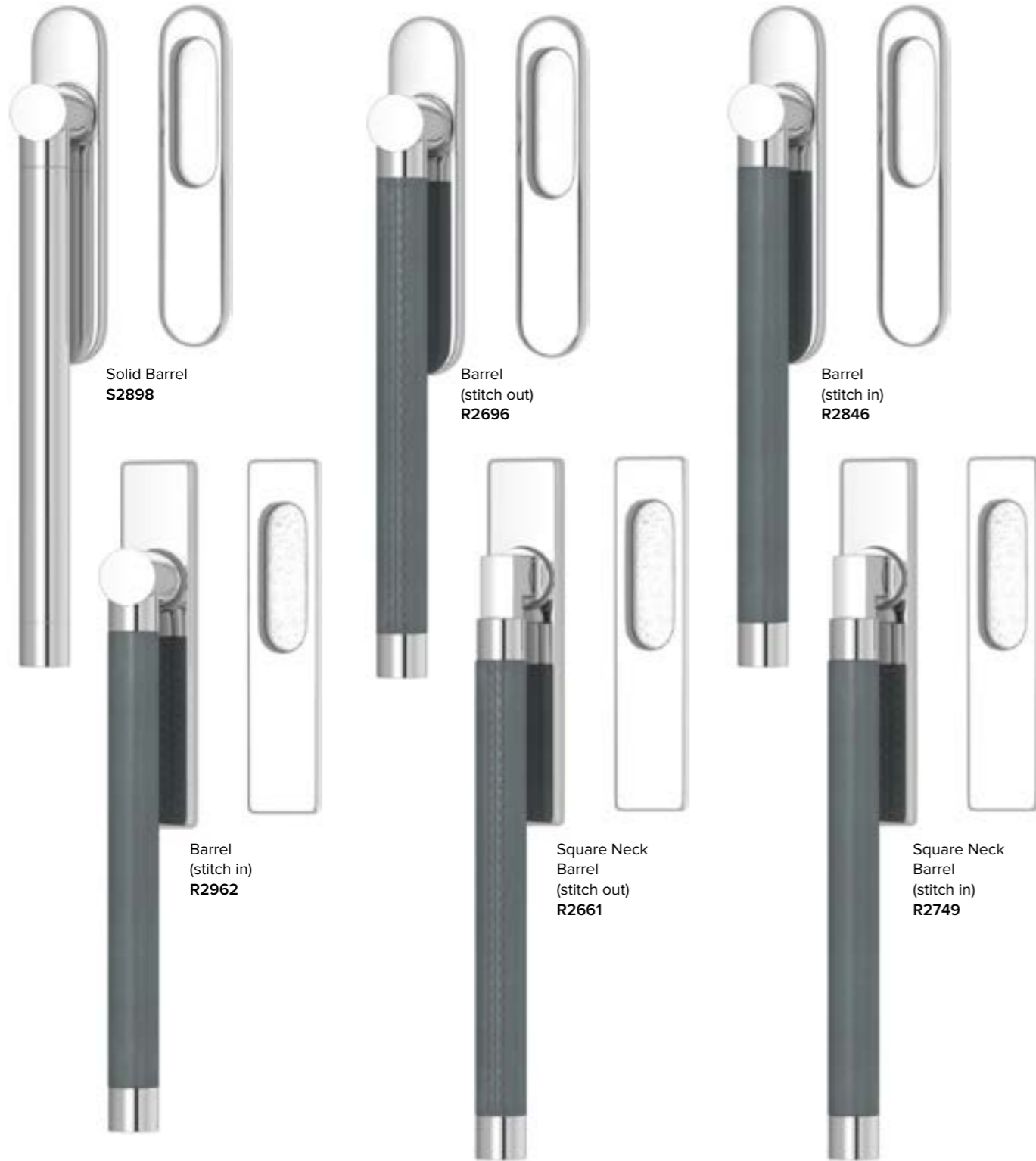

Above images are computer generated renders, please allow for some variation from actual product.

Dimensions index p110. For full technical specifications contact our sales department or visit www.turnstyledesigns.com

tilt and turn window handles

Use any of our door levers in conjunction with our tilt and turn window mechanisms and roses, designed to work with most multipoint casement window systems.

Shown here a selection of design and finish options.

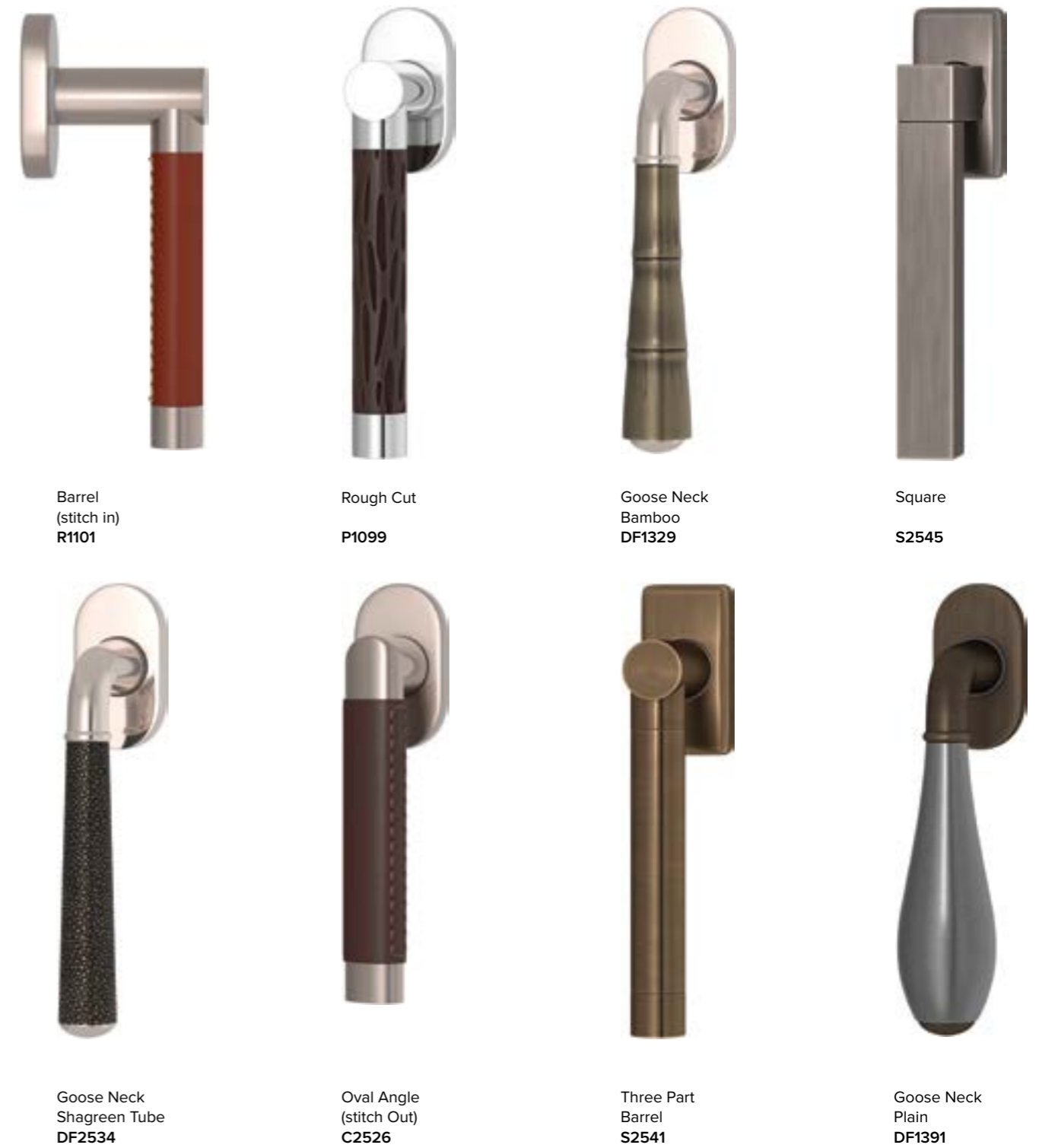
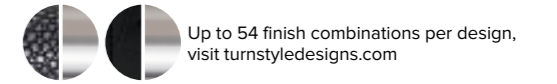

Above images are computer generated renders, please allow for some variation from actual product.

Dimensions index p110. For full technical specifications contact our sales department or visit www.turnstyledesigns.com

solid and combination T bar handles

Machined with an 8mm spindle follower to work on espagnolette systems to lock cupboards or doors. Elegantly waisted bodies with tapered grips available in Amalfine™, solid or hammered brass and leather available on all roses to compliment our door levers.

Shown here on 52mm round rose in Bright Chrome, Chocolate Leather or Cocoa with Bright Chrome.

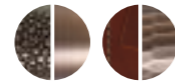

Up to 54 finish combinations per design, visit turnstyledesigns.com



Solid Tube **S1686**



Solid Hammered Tube **HS1686**



Combination Leather Tube (stitch in) **C1481**



Combination Leather Tube (stitch out) **C1290**



Combination Amalfine™ Shagreen Tube **D2584**



Combination Amalfine™ Faceted Tube **D1811**



Combination Amalfine™ Tube **D1686**



Combination Amalfine™ Bamboo **D1291**

solid and recess T bar handles

Solid brass, Amalfine™ or leather grips on a simple barrel base or our new Stepped Labyrinth designs, also available in a smaller cabinet handle option to match (see Cabinet handle brochure).

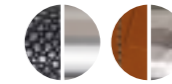

Up to 54 finish combinations per design, visit turnstyledesigns.com

Grips available in Amalfine™, solid or hammered brass and leather.

Shown here on 52mm round rose in Bright Chrome, Chocolate Leather or Cocoa with Bright Chrome.



Solid Barrel **S2017**



Solid Hammered Barrel **HS2017**



Recess Leather Barrel (stitch in) **R1913**



Recess Leather Barrel (stitch out) **R1911**



Recess Amalfine™ Barrel **P2017**



Recess Amalfine™ Rough Cut **P2359**



Recess Amalfine™ Shagreen **P1912**



Recess Amalfine™ Wire **P2361**



Recess Amalfine™ Woven **P2230**



Recess Amalfine™ Faceted **P3408**



Stepped Recess Amalfine™ Labyrinth **B8254**

recess Amalfine™ pull handles

Seven of our best selling Amalfine™ grip designs beautifully finished in our Amalfine™ and metal finishes. Tactile and durable these bold designs will be the finishing touch on any project. Door pulls come in three standard sizes plus our multi grip extended sizes, with a choice of 45mm or 65mm projections for doors or cupboards. Bolt fix, face or back to back fixing.

Shown here in Alupewt with Satin Nickel. Ø25mm, 65mm projection.

Up to 45 finish combinations per design, visit turnstyledesigns.com

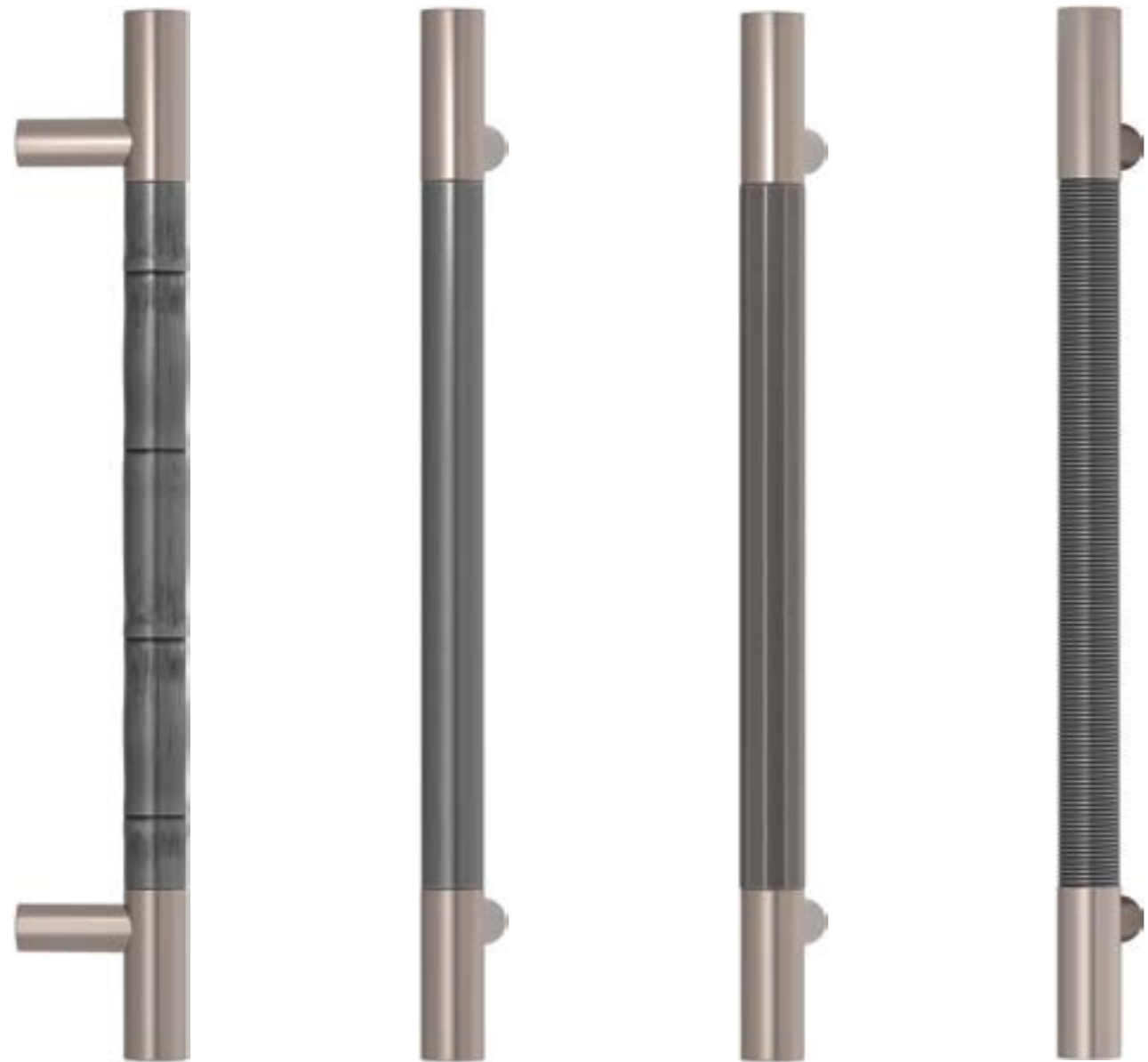
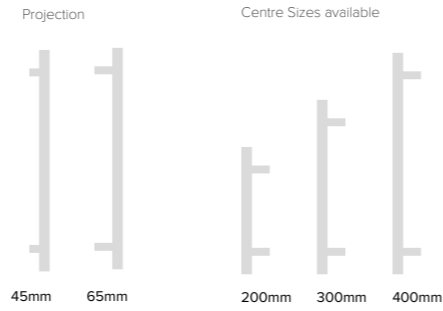

Bamboo P2876

Barrel P1340

Faceted Barrel P2645

Wire P2991



Shagreen P1079

Rough Cut P1076

Woven P2822

recess Amalfine™ pull handles

Up to 45 finish combinations per design, visit turnstyledesigns.com

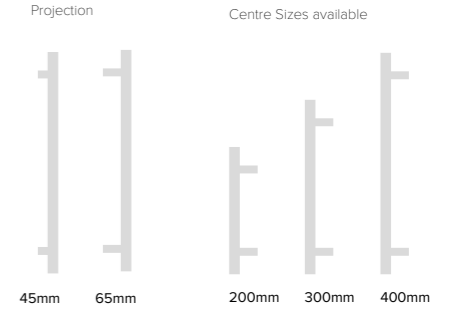



Photo courtesy of Blenheim Park Developments www.bpd ltd.co.uk
 Shown here - Shagreen Multi-Grip in Sand with Bright Chrome

recess Amalfine™ pull handles

Available in seven diverse designs, our multi grip door pulls give you the option for larger doors. With 45mm or 65mm projections and a choice of fixings including decorative caps for bolt fixing.

Shown here in Wire Alupewt with Satin Nickel.

Up to 45 finish combinations per design, visit turnstyledesigns.com

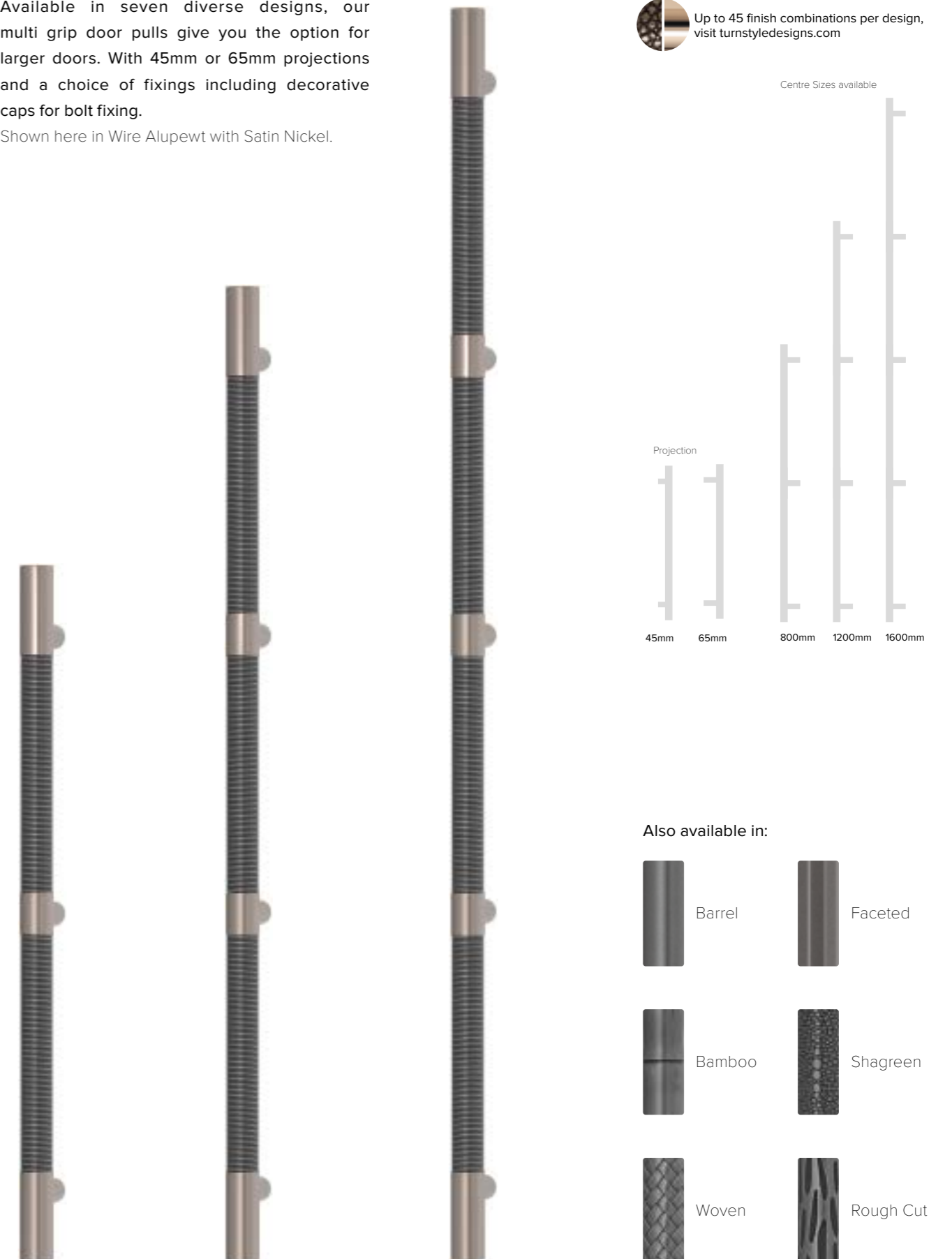

Above images are computer generated renders, please allow for some variation from actual product.

Dimensions index p111. For full technical specifications contact our sales department or visit www.turnstyledesigns.com



Shown here – Labyrinth collection in Silver Bronze with Polished Nickel

stepped recess Amalfine™ Labyrinth pull handles

Designed in collaboration with renowned design house, Winch Design, our new Labyrinth design is a complex pattern inspired by nature and available in the full collection of products from cabinet knobs to T bars. Shown here in Alupewt with a selection of our brass finishes.

Up to 45 finish combinations per design, visit turnstyledesigns.com



Labyrinth | B7444
Satin Nickel Polished Nickel Polished Brass Fine Antique Brass Vintage Nickel Vintage Patina

Also available in Bright Chrome (BC), Satin Brass Waxed (TW) and Matt Black Chrome (CB)

Above images are computer generated renders, please allow for some variation from actual product.

Dimensions index p111. For full technical specifications contact our sales department or visit www.turnstyledesigns.com

goose neck combination Amalfine™ pull handles

Suitable for doors, cupboards or appliances and available with matching door and window levers.
Shown here in Black Bronze with Polished Brass.

Up to 45 finish combinations per design, visit turnstyledesigns.com



Woven Tube DF1199



Plain DF1593



Tube DF1600

goose neck combination Amalfine™ pull handles

Up to 45 finish combinations per design, visit turnstyledesigns.com



Faceted Tube DF1858



Bamboo DF1059



Shagreen Tube DF2631



solid and hammered pull handles

Goose neck, combination or recess – solid, simple and reliable. The Barrel design is also available with 45mm and 65mm projection options. Shown here in Polished Brass.

Up to 9 finishes per design, visit turnstyledesigns.com

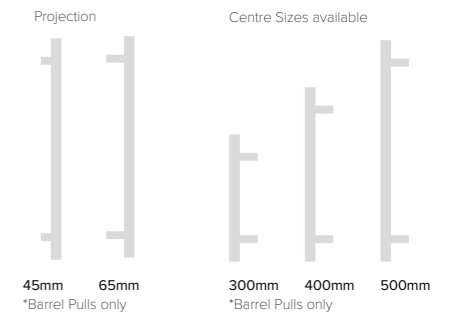

Goose Neck Tube
SF1600



Goose Neck Hammered Tube
HF1600



Barrel
S1340



Hammered Barrel
HS1340

Shown here – Hammered Goose Neck
in Burnished Brass

Above images are computer generated renders, please allow for some variation from actual product.





Shown here - Barrel Door Pulls in Chestnut Leather with Polished Nickel

recess leather pull handles

Our recess leather pulls now run from a 12mm diameter cabinet pull through five increasing diameters to our large 32mm barrel pull, with sizes from 64mm to 1500mm standard plus any length you want in custom options. Stitch in or out and with a choice of projections for doors or appliance/cupboards, fixed any way you want. Shown here in Slate Grey Leather with Satin Nickel.

Up to 54 finish combinations per design, visit turnstyledesigns.com

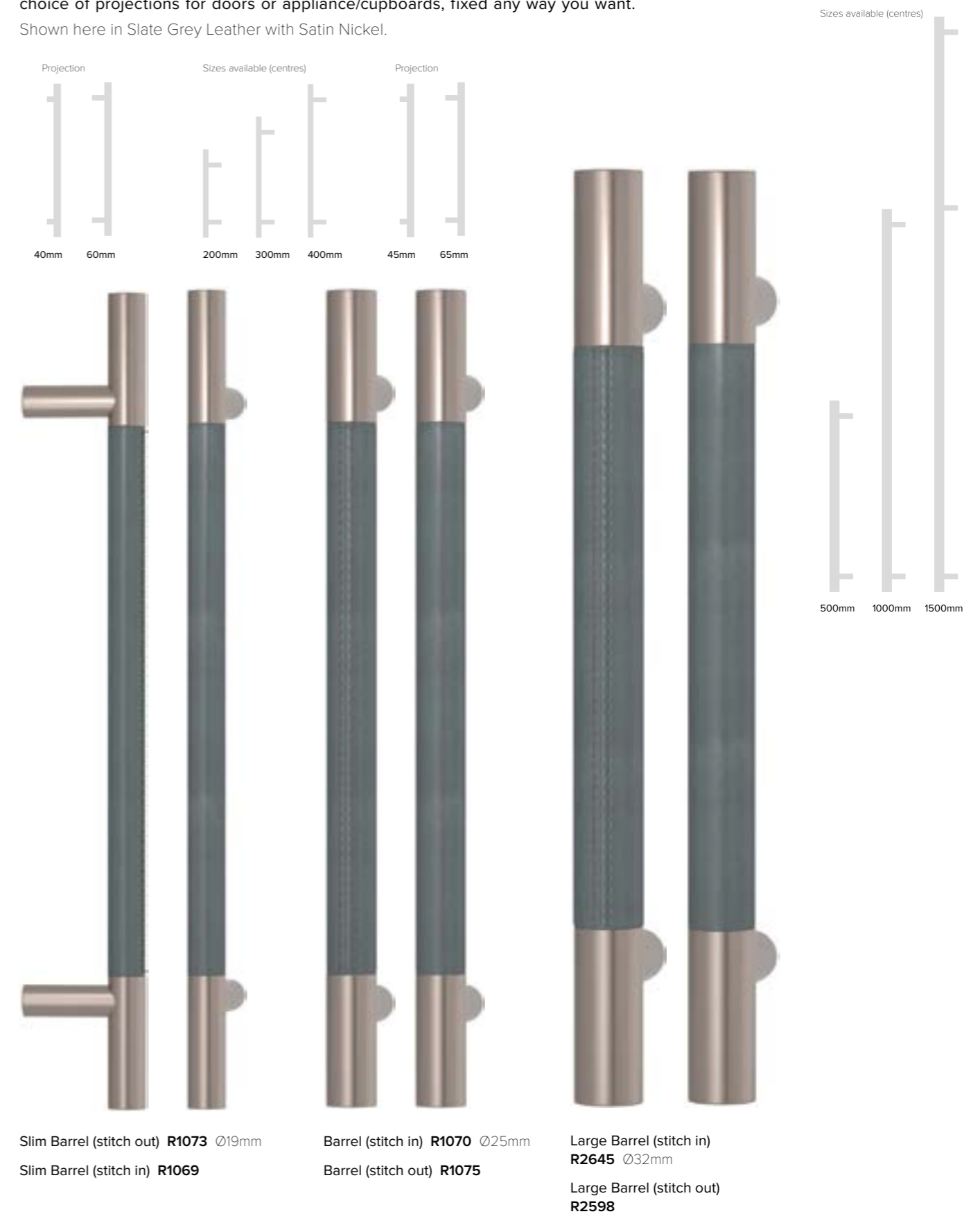

Above images are computer generated renders, please allow for some variation from actual product.

Dimensions index p111. For full technical specifications contact our sales department or visit www.turnstyledesigns.com

goose neck combination leather pull handles

Four simple options of the same design, our popular Tube leather pull handles, suitable for full sized doors and cupboards. Matching door, cabinet and window hardware is also available.

Shown here in Slate Grey Leather with Polished Nickel.

Up to 42 finish combinations per design, visit turnstyledesigns.com



Tube Split (stitch out) CF1607

Tube Split (stitch in) CF1608

Tube Long (stitch out) CF1611

Tube Long (stitch in) CF1416

Shown here - Goose Neck Tube Long Door Pull in Tan Leather with Bright Chrome

Above images are computer generated renders, please allow for some variation from actual product.

Dimensions index p111. For full technical specifications contact our sales department or visit www.turnstyledesigns.com

leather and solid push plates

Solid brass or wrapped leather push plates, available in our standard size or made to measure for custom options.

Shown here in Chocolate Leather and Vintage Nickel.

Up to 9 finishes per design, visit turnstyledesigns.com

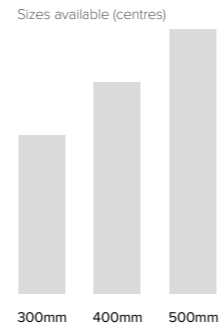

Embossed Leather Push Plate
X1288 | Chocolate Leather



Leather Push Plate
X1590 | Chocolate Leather



Solid Push Plate
S1082 | Vintage Nickel

recess leather pull handles

Solid 25mm brass square section, available in three standard lengths. Hand stitched with durable vegetable tanned leather grips. Available with fittings for timber or glass doors. Square profile cabinet handles are available to match. See our cabinet handle brochure or website.

Shown here in Chocolate Leather with Vintage Nickel.

Up to 54 finish combinations per design, visit turnstyledesigns.com

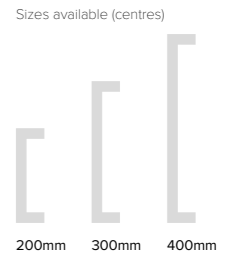

Ski
R1592



Square Short (stitch out)
R1072 □ 25mm (1")

Also available in
Square Short (stitch in)
R1067 □ 25mm (1")



Square Long (stitch out)
R1074 □ 25mm (1")

Also available in
Square Long (stitch in)
R1068 □ 25mm (1")

Above images are computer generated renders, please allow for some variation from actual product.

Above images are computer generated renders, please allow for some variation from actual product.



recess leather pull handles

Coffin leg scroll pull handles, stitch in or out to match our popular Scroll cabinet handles. Simple and contemporary pulls available in two lengths with a 22mm diameter grip.

Shown here in Slate Grey Leather with Satin Nickel. Ø22mm

Up to 54 finish combinations per design, visit turnstyledesigns.com

Sizes available (centres)

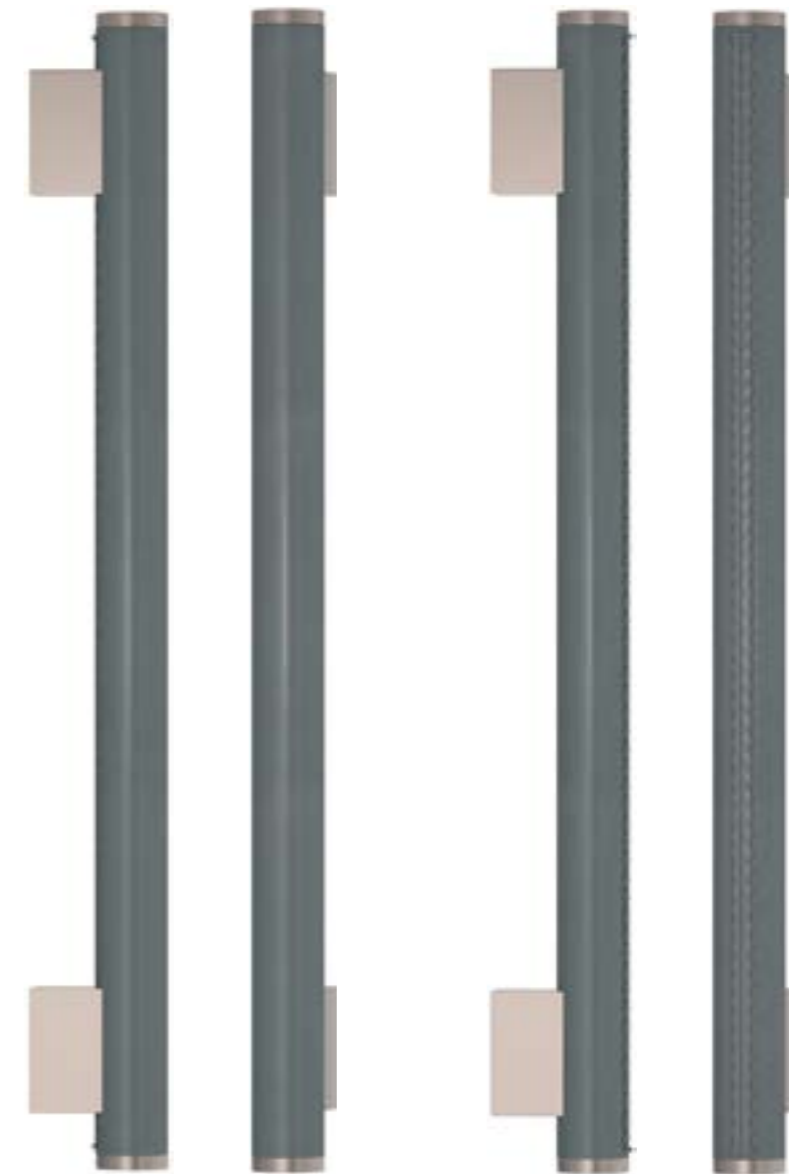

Coffin leg Scroll (stitch in)
R1120

Coffin leg Scroll (stitch out)
R1133

Shown here – Coffin Leg Scroll Pull Handle in Chocolate Leather with Polished Nickel



recess woven leather pull handles

Our luxurious woven leather pull handles, flat strips of leather woven into a seamless tube and bonded onto 22mm or 16mm grips, available in four distinct woven leather finishes.

Shown here in Whisky Leather and Raven Black Leather with Vintage Patina.



Up to 36 finish combinations per design, visit turnstyledesigns.com

Sizes available (centres)

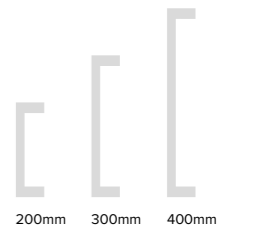

Slim Woven Barrel
R2235 Ø16mm



Woven Barrel
R2077 Ø22mm

Shown here – in Raven Black with Vintage Nickel

Above images are computer generated renders, please allow for some variation from actual product.

Dimensions index p111. For full technical specifications contact our sales department or visit www.turnstyledesigns.com

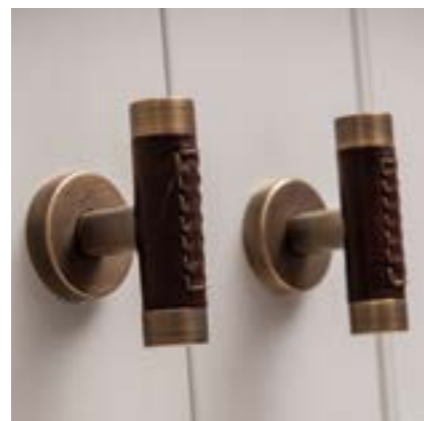

For a complete look to any interior, make sure you take a look at our Furniture Brochure. Where you will find many more of our products and collections to suit any design style.

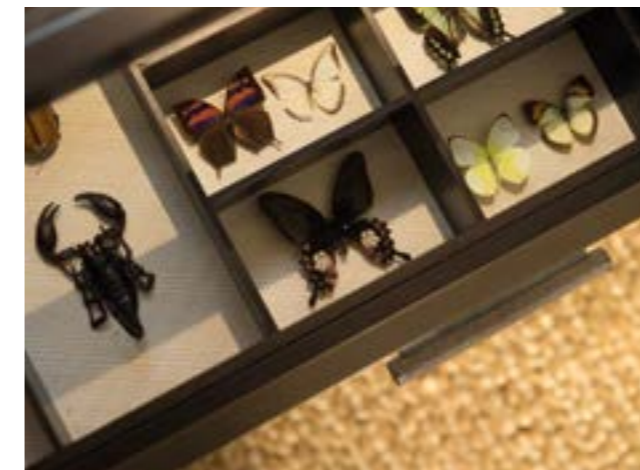
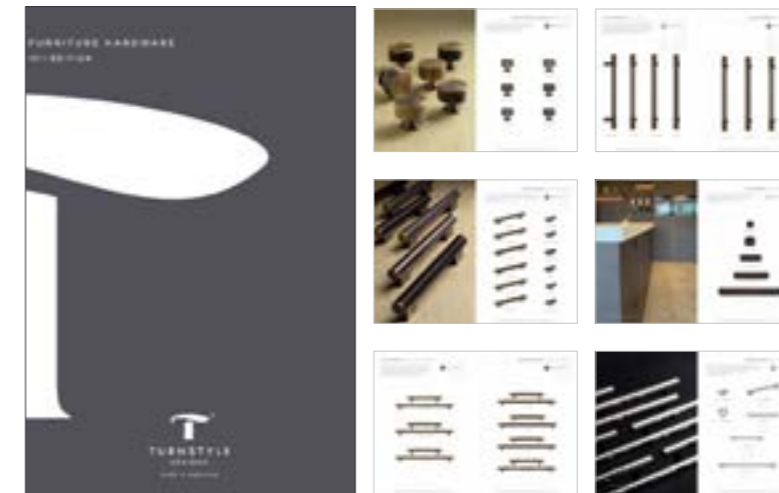



Photo courtesy of Pacific Rim, Oregon - www.pacificrimsashanddoor.com
Shown here - Custom Offset Recess Leather Barrel Door Pull on Backplate

customisation

Modify

We offer modification and customisation options for clients by using existing stock components.

A cost effective way to enable a client to have a unique, bespoke design by using some of Turnstyles' stocked components and modifying material, grips or finish and thereby benefiting from both price and delivery times.

There are several ways of achieving this... here are the main areas:

Custom Leather

Clients can free issue their leather to apply to an existing design, or modify our stitch colour or style.

Custom Grip

Create your own grip for any of our hardware, and choose your own materials and lengths.

Custom Metal

Alongside our standard metals we have a range of custom finish options including Rose Gold, Vintage Copper and Silver Plate.



Tailored

If you are not able to find something to suit your project in either of our catalogue ranges or via the Modify process we will be happy to discuss developing and manufacturing your vision from start to finish.

We have the capabilities and know-how to manufacture most types of door hardware, however complex, and have been the manufacturer of choice for some of the most prestigious and demanding clients in the world, including a number of Superyacht builders.

We understand the demands put on door and cabinet hardware and will ensure that your design not only looks a million dollars but it is also built to last and function smoothly.

In the first instance please contact our custom design department at our head office and ask for Alex Foster on + 44 (0)1271 325 325 or email alex@turnstyledesigns.com. Alex will discuss the project, designs and suitability (to develop time scales and budget indications) from prototyping to full delivery.



Dimensions

page 19 goose neck combination door levers on classic rose



	C	L	P	W
DF3556	-	125	69	20
DF4123	-	127	69	20
DF6060	-	127	69	20
DF4455	-	134	72	25
CF4090	-	128	70	20
CF5050	-	128	70	20
SF6060	-	127	69	20
HF6060	-	128	69	20
SF4455	-	134	72	25

page 20 goose neck combination Amalfine™ door levers

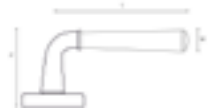

	C	L	P	W
DF3260	-	134	72	25
DF3270	-	125	69	20
DF3025	-	127	77	35
DF3015	-	127	69	20

page 21 goose neck combination Amalfine™ door levers

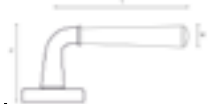

	C	L	P	W
DF2988	-	127	69	20
DF1175	-	127	69	20
DF3009	-	127	72	25

page 22 combination Amalfine™ door levers



	C	L	P	W
D3200	-	139	68	30

page 23 goose neck combination Amalfine™ door levers



	C	L	P	W
DF3290	-	148	74	30

page 25 pipe recess Amalfine™ door lever

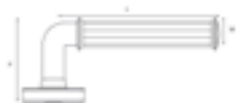

	C	L	P	W
QA2020	-	148	65	25

page 26 combination Amalfine™ door levers

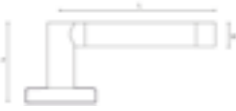

	C	L	P	W
D1002	-	116	71	35
D1332	-	117	63	20
D3240	-	124	66	25
D3280	-	115	64	20

page 27 combination Amalfine™ door levers

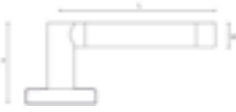

	C	L	P	W
D1001	-	113	66	25
D1182	-	117	63	20
D2005	-	117	63	20

page 30 recess Amalfine™ door levers

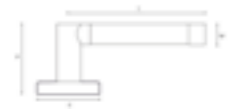

	C	L	P	W
P2856	-	123	62	19
P1440	-	122	62	21
P2702	-	125	62	19
P1333	-	125	62	19
P2771	-	135	62	19

page 31 recess Amalfine™ door levers

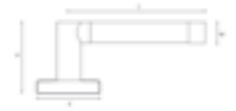

	C	L	P	W
P2670	-	125	62	19
P2765	-	125	62	19
P1019	-	125	62	19
P1015	-	125	62	19

page 33 stepped Amalfine™ Labyrinth door lever

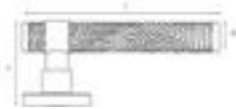

	C	L	P	W
B7005	-	132	70	25

page 35 balance Amalfine™ door lever



	C	L	P	W
E3500	-	110	60	30

page 38 solid hammered door levers

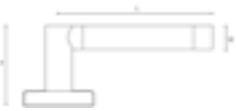

	C	L	P	W
HS1526	-	125	62	19
HS1022	-	112	61	25
HS5004	-	123	60	26
HS1333	-	124	62	19
HS2037	-	124	62	19

page 39 solid hammered door levers

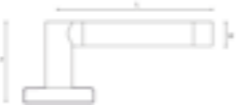

	C	L	P	W
HS1332	-	117	63	20
HF3015	-	128	69	20
QH2700	-	148	65	25

page 41 solid door levers

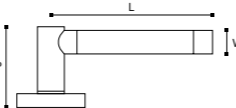

	C	L	P	W
S1429	-	116	61	20
S1526	-	125	62	19
S1333	-	124	62	19
S1022	-	112	61	25
S2037	-	124	62	19
S5004	-	123	60	26

page 43 solid door levers



	C	L	P	W
QS2700	-	148	65	25
QS2020	-	148	65	25
S1332	-	117	63	20
SF3260	-	134	71	25
SF3015	-	127	69	20
S3240	-	124	66	25

page 46 recess leather door levers

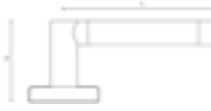

	C	L	P	W
R1022	-	113	61	25
R1025	-	126	62	19
R1021	-	126	62	19
R1941	-	126	62	19
R2030	-	126	62	19

page 47 recess leather door levers

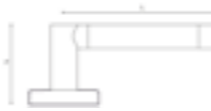

	C	L	P	W
R1024	-	123	62	19
R1018	-	123	62	19
R3073	-	144	64	22
R3083	-	144	64	22
R1023	-	123	62	19
R1020	-	123	62	19
HR1023	-	123	62	19
HR1025	-	126	62	19

page 49 recess woven leather door levers

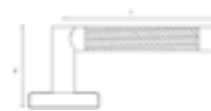

	C	L	P	W
R2076	-	123	62	19

page 51 pipe recess leather door levers



	C	L	P	W
QL2242	-	148	65	25
QL2004	-	148	65	25

page 53 combination leather door levers



	C	L	P	W
C1012	-	117	63	20
C1000	-	117	63	20
C1414	-	116	61	24
CF2992	-	128	70	20
CF2987	-	128	70	20
C1013	-	116	61	24

page 57 recess Amalfine™ stacked door knobs

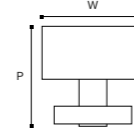

	C	L	P	W
P6711	-	52	65	52
P6200	-	52	65	52
B9303	-	52	65	52
P4224	-	52	65	52
P6587	-	52	65	52
P6702	-	52	65	52

page 59 recess Amalfine™ layer door knobs

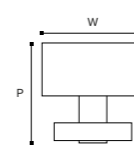

	C	L	P	W
P2244	-	57	70	57

page 61 solid, hammered and recess leather door knobs

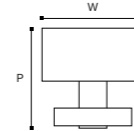

	C	L	P	W
S9200	-	52	65	52
HS9200	-	52	65	52
R4224	-	52	65	52

page 63 combination Amalfine™ and solid door knobs



	C	L	P	W
D7568	-	70	75	48
S7568	-	70	75	48
D6633	-	58	83	58

page 65 escutcheons – key hole covers

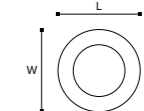

	C	L	P	W
S1423	-	52	10	52
S1421	-	52	10	52
S1426	-	52	10	52
S1424	-	52	10	52
S1450	-	58	10	58
S7769	-	52	8	52
S5200	-	52	5	52
S1422	-	52	10	52
S1428	-	52	10	52
S1672	-	52	10	52
S1478	-	58	10	58
S7907	-	52	8	52
S5277	-	52	5	52
S1630	-	52	10	52
S1725	-	52	10	52
S2764	-	52	10	53
S2802	-	52	10	53

page 66 thumb turn sets

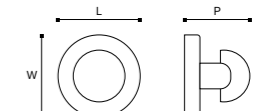

	C	L	P	W
S1042	-	52	41	52
S3010	-	52	41	52
S1071	-	58	41	58
S5122	-	52	34	52
S1420	-	52	41	52
S2020	-	52	39	52
HS1042	-	52	41	52
HS3010	-	52	41	52
HS1071	-	58	41	58
HS5122	-	52	34	52
HS1420	-	52	41	52
HS2020	-	52	39	52

Dimensions

page 67 thumb turn sets

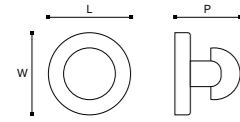

	C	L	P	W
S1041	-	52	41	52
S3043	-	52	41	52
S1076	-	58	41	58
S3857	-	52	39	52
S1046	-	52	41	52
S8234	-	52	40	52
S8536	-	52	40	52
S8400	-	58	40	58
S8007	-	52	38	52
S8425	-	52	40	52
S9559	-	37	40	37

page 68 door stops and hardware

	C	L	P	W
X1123	-	49	43	49
X1125	-	41	75	41
X1124	-	25	35	25
X1126	-	126	-	35
X2046	-	40	55	35
X2596	-	40	75	40
X1121	-	203	-	19
X1121	*	254	-	19

page 71 solid pocket/sliding door pulls

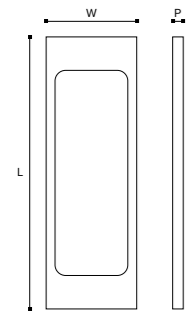

	C	L	P	W
S1954	-	70	3	70
S2829	-	70	4	70
S1407	-	124	-	19
S1955	-	178	3	57
S1920	-	245	2	35

page 73 recess leather pocket/sliding door pulls

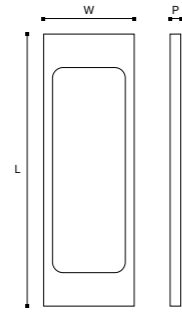

	C	L	P	W
C1954	-	70	3	70
R1955	-	178	3	57
R3123	-	256	4	94
R3150	-	250	4	70
C1959	-	245	2	35

page 76 solid and recess leather lift and slide handles

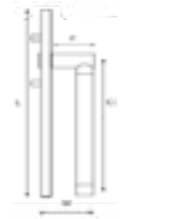

	C	L	P	W
S2898	80	240	68	32
R2962	80	240	68	32
R2696	80	240	68	32
R2661	80	240	68	32
R2846	80	240	68	32
R2749	80	240	68	32

page 77 tilt and turn window handles

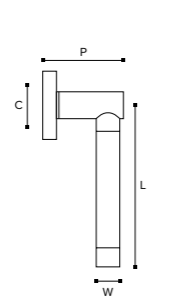

	C	L	P	W
R1101	43	123	62	19
DF2534	43	127	69	20
P1099	43	125	62	19
C2526	43	116	61	24
DF1329	43	127	72	25
S2541	43	124	62	19
S2545	43	125	62	20
DF1391	43	127	77	35

page 78 solid and combination T-bar handles

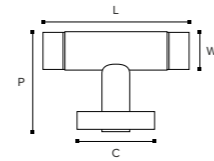

	C	L	P	W
S1686	52	84	65	20
HS1686	52	84	65	20
C1481	52	84	65	20
C1290	52	84	65	20
D2584	52	84	65	20
D1811	52	84	65	20
D1686	52	84	65	20
D1291	52	84	65	20

page 79 solid and recess T-bar handles

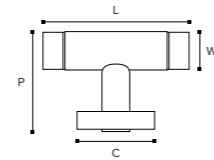

	C	L	P	W
S2017	52	82	65	19
HS2017	52	82	65	19
R1913	52	82	65	19
R1911	52	82	65	19
P2017	52	82	65	19
P2359	52	82	65	19
P1912	52	82	65	19
P2361	52	82	65	19
P2230	52	82	65	19
P3408	52	82	65	19
B8254	52	82	65	19

page 82 recess Amalfine™ pull handles



	C	L	P*	W
P2876	200	300	65	25
P2876	300	400	65	25
P2876	400	500	65	25
P1340	200	300	65	25
P1340	300	400	65	25
P1340	400	500	65	25
P2645	200	300	65	25
P2645	300	400	65	25
P2645	400	500	65	25
P2991	200	300	65	25
P2991	300	400	65	25
P2991	400	500	65	25

*45mm projection available

page 83 recess Amalfine™ pull handles

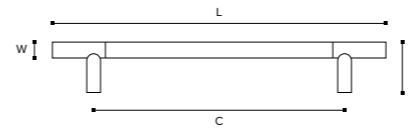

	C	L	P*	W
P1079	200	300	65	25
P1079	300	400	65	25
P1079	400	500	65	25
P1076	200	300	65	25
P1076	300	400	65	25
P1076	400	500	65	25
P2822	200	300	65	25
P2822	300	400	65	25
P2822	400	500	65	25

*45mm projection available

page 85 recess Amalfine™ pull handles

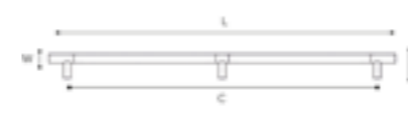

All Designs	C	L	P*	W
800	900	65	25	
1200	1300	65	25	
1600	1700	65	25	

*45mm projection available

page 87 stepped recess Amalfine™ labyrinth pull handles

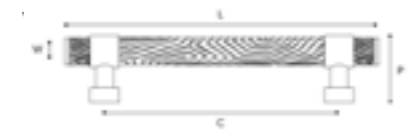

	C	L	P	W
B7444	300	375	66	25
B7444	400	475	66	25

page 88 goose neck combination



	C*	L	P	W
DF1199	247	267	60	21
DF1593	245	265	67	35
DF1600	247	267	59	20

*Hand made, centres may vary

page 89 goose neck combination Amalfine™ pull handles



	C*	L	P	W
DF1858	242	262	62	20
DF1059	239	259	62	25
DF2631	247	267	59	20

*Hand made, centres may vary

page 91 solid and hammered pull handles

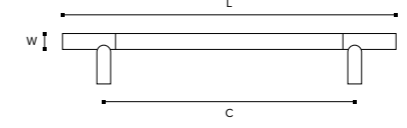

	C	L	P	W
SF1600	247	267	59	20
HF1600	247	267	59	20
S1340*	300	400	65	25
S1340*	400	500	65	25
S1340*	500	600	65	25
HS1340*	300	400	65	25
HS1340*	400	500	65	25
HS1340*	500	600	65	25

*45mm projection available

page 95 recess leather pull handles

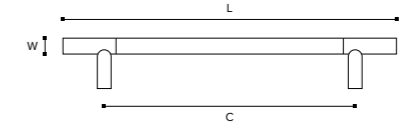

	C	L	P	W
R1073*1	200	300	60	19
R1073*1	300	400	60	19
R1073*1	400	500	60	19
R1069*1	200	300	60	19
R1069*1	300	400	60	19
R1069*1	400	500	60	19
R1070*2	200	300	65	25
R1070*2	300	400	65	25
R1070*2	400	500	65	25
R1075*2	200	300	65	25
R1075*2	300	400	65	25
R1075*2	400	500	65	25
R2645	500	620	78	32
R2645	1000	1120	78	32
R2645	1500	1620	78	32
R2598	500	620	78	32
R2598	1000	1120	78	32
R2598	1500	1620	78	32

*1 - 40mm projection available

*2 - 45mm projections available

page 97 goose neck combination leather pull handles



	C	L	P	W
CF1607	247	267	59	20
CF1608	247	267	59	20
CF1611	268	288	59	20
CF1416	268	288	59	20

page 98 leather and solid push plates

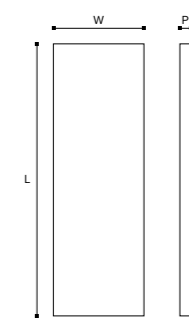

	C	L	P	W
X1288	-	300	4	80
X1590	-	300	4	80
S1082	-	300	3	80

page 99 recess leather pull handles



	C	L	P	W
R1072	200	225	65	25
R1072	300	325	65	25
R1072	400	425	65	25
R1067	200	225	65	25
R1067	300	325	65	25
R1067	400	425	65	25
R1074	200	225	65	25
R1074	300	325	65	25
R1074	400	425	65	25
R1068	200	225	65	25
R1068	300	325	65	25
R1068	400	425	65	25
R1592	226	245	48	25

page 101 recess leather pull handles

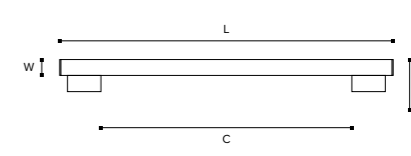

	C	L	P	W
R1120	300	350	65	22
R1120	400	450	65	22
R1133	300	350	65	22
R1133	400	450	65	22

page 103 recess leather woven pull handles

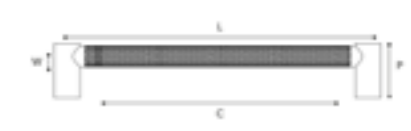

	C	L	P	W
R2235	200	222	63	16
R2235	300	322	63	16
R2235	400	422	63	16
R2077	200	228	63	22
R2077	300	328	63	22
R2077	400	428	63	22

Index

Part Code	Page
B7005	33
B7444	87
B8254	79
B9303	57
C1000	53
C1012	53
C1013	53
C1290	78
C1414	53
C1481	78
C1954	73
C1959	73
C2526	77
CF1416	97
CF1607	97
CF1608	97
CF1611	97
CF2987	53
CF2992	53
CF4090	19
CF5050	19
D1001	27
D1002	26
D1182	27
D1291	78
D1332	26
D1686	78
D1811	78
D2005	27
D2584	78
D3200	22
D3240	26
D3280	26
D6633	63
D7568	63
DF1059	89
DF1175	21
DF1199	88
DF1329	77
DF1391	77
DF1593	88
DF1600	88
DF1858	89
DF2534	77
DF2631	89
DF2988	21
DF3009	21
DF3015	20
DF3025	20
DF3260	20
DF3270	20
DF3290	23
DF3556	19
DF4123	19
DF4455	19
DF6060	19

Part Code	Page
E3500	35
HF1600	91
HF3015	39
HF6060	19
HR1023	47
HR1025	47
HS1022	38
HS1042	66
HS1071	66
HS1332	39
HS1333	38
HS1340	91
HS1420	66
HS1526	38
HS1686	78
HS2017	79
HS2020	66
HS2037	38
HS3010	66
HS5004	38
HS5122	66
HS9200	61
K1500	71
K2692	71
K2693	71
PI015	31
PI019	31
PI076	83
PI079	83
PI099	77
PI333	30
PI340	82
PI440	30
PI912	79
P2017	79
P2230	79
P2244	59
P2359	79
P2361	79
P2645	82
P2670	31
P2702	30
P2765	31
P2771	30
P2822	83
P2856	30
P2876	82
P2991	82
P3408	79
P4224	57
P6200	57
P6587	57
P6702	57
P6711	57
QA2020	25
QH2700	39

Part Code	Page
QL2004	51
QL2242	51
QS2020	43
QS2700	43
R1018	47
R1020	47
R1021	46
R1022	46
R1023	47
R1024	47
R1025	46
R1068	99
R1067	99
R1069	95
R1070	95
R1072	99
R1073	95
R1074	99
R1075	95
R1101	77
R1120	101
R1133	101
R1592	99
R1911	79
R1913	79
R1941	46
R1955	73
R2030	46
R2076	49
R2077	103
R2235	103
R2598	95
R2645	95
R2661	76
R2696	76
R2749	76
R2846	76
R2962	76
R3073	47
R3083	47
R3123	73
R3150	73
R4224	61
S1022	41
S1041	67
S1042	66
S1046	67
S1071	66
S1076	67
S1082	98
S1332	43
S1333	41
S1340	91
S1407	71
S1420	66
S1421	65

Part Code	Page
S1422	65
S1423	65
S1424	65
S1426	65
S1428	65
S1429	41
S1450	65
S1478	65
S1526	41
S1630	65
S1686	78
S1725	65
S1920	71
S1954	71
S1955	71
S2017	79
S2020	66
S2037	41
S2541	77
S2545	77
S2802	65
S2829	71
S2898	76
S3010	66
S3043	67
S3240	43
S3857	67
S5004	41
S5122	66
S5200	65
S5277	65
S7568	63
S7769	65
S7907	65
S8007	67
S8234	67
S8400	67
S8425	67
S8536	67
S9200	61
S9559	67
SF1600	91
SF3015	43
SF3260	43
SF4455	19
SF6060	19
X1121	68
X1123	68
X1124	68
X1125	68
X1126	68
X1288	98
X1590	98
X2046	68
X2596	68



Only sustainably sourced paper and vegetable based inks were used in the production of this brochure.



+44(0) 1271 325 325 | +1 877 288 4642

WWW.TURNSTYLEDESIGNS.COM